

DNMI

DET NORSKE METEOROLOGISKE INSTITUTT

klima

The effect of radiation screens on Nordic temperature measurements

**P.Ø. Nordli, H. Alexandersson, P. Frich, E. Førland, R. Heino, T. Jónsson, P. Steffensen,
H. Tuomenvirta, O.E. Tveito**

REPORT NO. 4/96 KLIMA

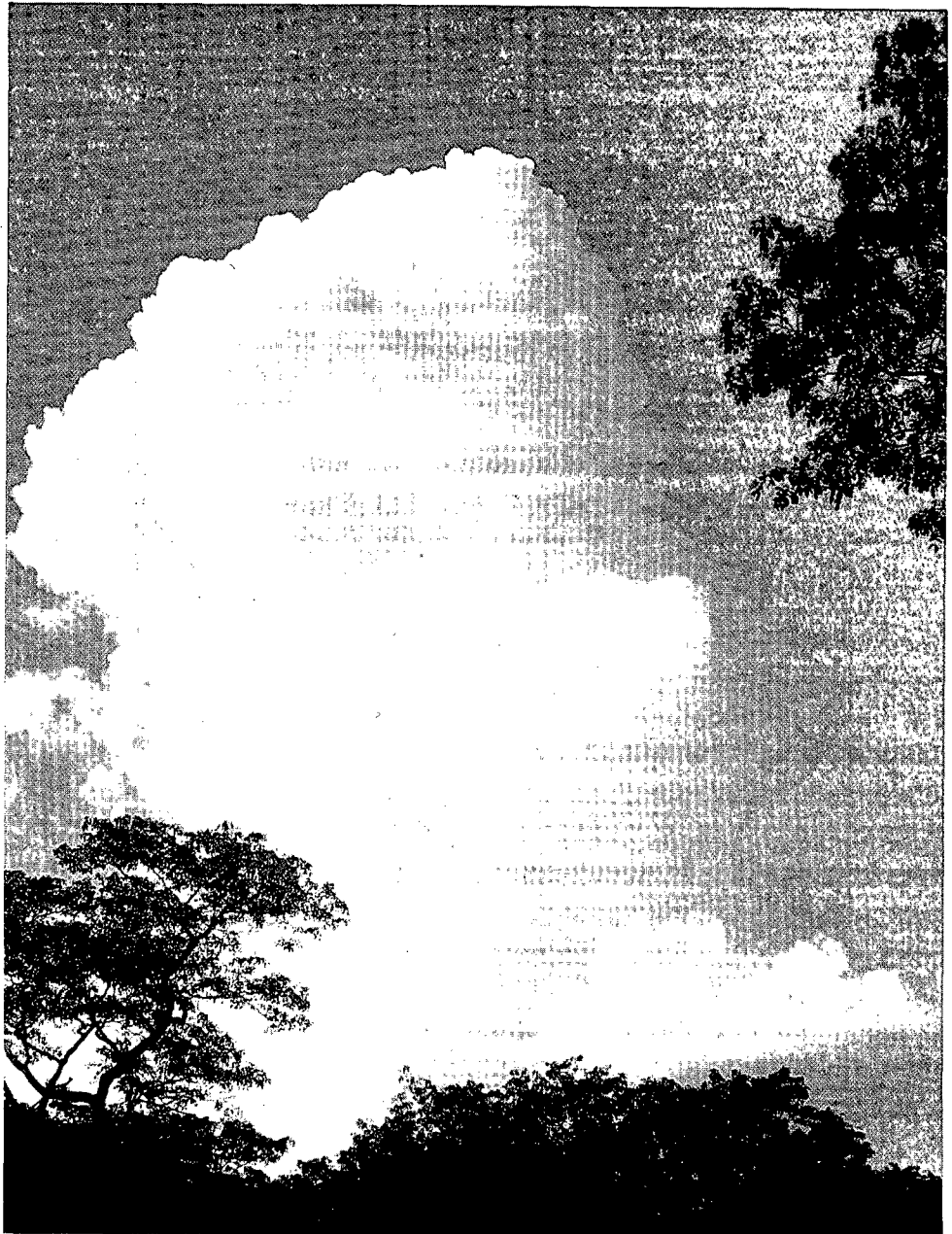

DNMI - RAPPORT

ISSN 0805-9918

NORWEGIAN METEOROLOGICAL INSTITUTE
BOX 43 BLINDERN , N - 0313 OSLO

REPORT NO.
4/96 KLIMA

PHONE +47 22 96 30 00

DATE
24.01.96

TITLE

The effect of radiation screens on Nordic temperature measurements

AUTHORS

P.Ø. Nordli, H. Alexandersson, P. Frich, E. Førland, R. Heino, T. Jónsson, P. Steffensen, H. Tuomenvirta, O.E. Tveito

PROJECT CONTRACTORS

European Commission, Nordic Council of Ministers, SILMU, Norwegian Research Council and the Nordic meteorological institutes.

ABSTRACT

Based upon search in the archives of the Nordic meteorological institutes a short survey of the historical development of temperature radiation screens is given. In the middle of the nineteenth century most thermometer stands were open shelters, free-standing or fastened to a window or wall. Most of them were soon replaced by wall or window screens, i.e. small wooden or metal cages. Already in the same century, the large free-standing screens were introduced. They replaced the wall screens over a rather long time span, and in the 1980s the replacement was completed in all Nordic countries. In the last years, small cylindrical screens suitable for automatic weather stations have been introduced. At some stations they have replaced the ordinary free-standing screen in connection with automation.

The first free-standing screens used in the Nordic countries were single louvered. They were later improved by double louvers. Compared to ventilated thermometers the monthly mean temperatures from the single louvered screens were biased 0.2 - 0.4°C warm in the season May - August, while the double louvered were unbiased. Unless the series are adjusted this improvement may lead to inhomogeneities in long climatic time series.

The change from wall screen to free-standing screen involved also relocation from the microclimatic influence of the house to a location free from obstacles. Tests by parallel measurements led to variable test results. However, the bulk of the tests gave no effect of the change in winter but there was a rather weak tendency of warmer wall screen during summer; 0.0 - 0.3°C compared to double louvered screen. At two Norwegian sites situated at steep valley slopes, the wall screen was colder in winter; 0.6°C and 0.4°C in January.

The novel sensor screen is probably unbiased compared to the ordinary free-standing screen concerning mean monthly temperature, but both daily maximum and minimum temperatures are biased mainly due to less inertia of the novel screen. Higher maximum and lower minimum lead to increased diurnal range. The increase may reach 1°C or more in midsummer monthly means.

The temperature time series of the Nordic countries have been tested for inhomogeneities. Some of the screen changes which were expected to influence the series were not detected by the test. The reason may be that other inhomogeneities were larger and therefore obscured those caused by screen changes. The screening effect may also depend on climate. Thus a change from single to double louvers was detected at the continental station Karasjok, but not at the coastal station Vardø, both stations are situated in Northern Norway.

SIGNATURE

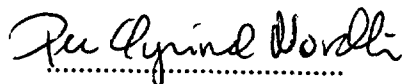

Per Øyvind Nordli
Senior scientist

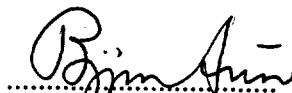

Bjørn Aune
Head of the Climatology Division

List of authors:

	Raino Heino ⁴
Per Øyvind Nordli ¹	Trausti Jónsson ⁵
Hans Alexandersson ²	Peter Steffensen ³
Povl Frich ³	Heikki Tuomenvirta ⁴
Eirik J. Førland ¹	Ole Einar Tveito ¹

The Nordic Meteorological Institutes

1. Det norske meteorologiske institutt (DNMI), Oslo, Norway.
2. Sveriges Meteorologiska och Hydrologiska Institut (SMHI), Norrköping, Sweden
3. Danmarks Meteorologiske Institut (DMI), Copenhagen, Denmark
4. Ilmatieteen Laitos (FMI), Helsinki, Finland
5. Veðurstofa Íslands (VI), Reykjavik, Iceland

The effect of radiation screens on Nordic temperature measurements

Content

<i>1 Introduction</i>	<i>4</i>
<i>2 Screens used in long time series</i>	<i>5</i>
<i>2.1 Measuring air temperature</i>	<i>5</i>
<i>2.2 The main types of screens</i>	<i>6</i>
<i>2.3 Description of screens used in each country</i>	<i>9</i>
<i>3 Test results of free-standing screens compared to ventilated thermometers</i>	<i>22</i>
<i>4 Test results from nineteenth century screens or shelters achieved by parallel measurements</i>	<i>26</i>
<i>5 Comparisons of free-standing screens and wall screens</i>	<i>28</i>
<i>5.1 Results from 6 Danish comparisons</i>	<i>29</i>
<i>5.2 Test results from Síðumúli and Eyrarbakki in Iceland.</i>	<i>32</i>
<i>5.3 Test results from Dombås, Norway</i>	<i>33</i>
<i>5.4 Short survey of earlier published Nordic test results</i>	<i>35</i>
<i>5.5 Summary and discussion</i>	<i>36</i>
<i>6 Comparisons of free-standing screens and sensor screens.</i>	<i>38</i>
<i>7 Results from statistical homogeneity testing procedures related to screen effects</i>	<i>41</i>
<i>7.1 Change from wall screen (open shelter) to free-standing screen</i>	<i>41</i>
<i>7.2 Changes caused by different types of free-standing screens</i>	<i>43</i>
<i>8 Summary and conclusions</i>	<i>44</i>
<i>References</i>	<i>47</i>
<i>APPENDIX I</i>	<i>51</i>
<i>APPENDIX II</i>	<i>52</i>

1 Introduction

It is estimated that the global mean surface temperature will increase about 0.3°C per decade in near future due to increasing concentration of CO₂ and other trace gases in the atmosphere (IPCC, 1992, 1995). The most recent regional downscaling of climate change scenarios for the Nordic region (Johannesson et al, 1995; Carter et al., 1995), indicate a mean annual temperature increase in this area by 0.30-0.45°C per decade due to increased greenhouse effect. During the last 135 years the mean global temperature has increased approximately 0.6°C (WMO, 1995).

In the international NACD-project (Frich et al, 1996), 11 countries in the North Atlantic region co-operated in creating a dataset of homogenous climatic series for the period 1890-1990. Analysis of the dataset shows that annual temperature in this region has increased by about 0.5°C during the last one hundred years (Hanssen-Bauer et al, 1996). However the variability in temperature due to natural fluctuations relative to the trend is high, and consequently a climatic change is not easy to detect. Detection is also obscured by problems associated with the measurements themselves.

In air temperature measurements, it is necessary to screen the thermometer from direct radiation from the sun and also from exchange of long wave radiation with the environment. The perfect screening, however, has so far not been invented so there may be a temperature difference between the thermometer bulb and the adjacent air outside the screen. The national meteorological institutes have considered improvements of radiation protection to be an important task, trying to get closer to the aim of obtaining «true» air temperature measurements. In doing so, however, they have introduced in the time series some inhomogeneities which may lead to biases in temperature trend studies.

Comparisons between different screens have been made as early as in the nineteenth century, e.g. DNMI (1875), Mawley (1897) and several others, and in the present century they are numerous. Recently Parker (1992) has studied available world wide literature about screen changes. In particular the emphasis was laid on the changes of exposure during the late nineteenth and early twentieth century. In the extratropical region he found that the early series may be biased 0.2°C warm in summer and by day and similar cold by winter and by night relative to modern observations.

Although the present report will deal with screen changes only, it should be kept in mind that this is not the only reason for inhomogeneities in temperature series. Other reasons are: Shrinking of the glass in thermometers, observation hours, i.e. time and number of observations per day, formulas for calculating daily and monthly mean temperature, screen height above ground, exposure to the environment like vegetation and buildings, relocation of the screen, urbanisation of the area near the screen. Some of these may in some cases even be of greater importance than changes of screens. It is therefore of crucial importance to adjust for inhomogeneities in time series.

2 Screens used in long time series

2.1 Measuring air temperature

When a thermometer is set into the air it will read the temperature of the adjacent air only if it is in equilibrium with the air. This is very seldom true. The difference between the bulb and the air may reach 25°C under extremely unfavourable conditions (WMO, 1983). Therefore it is necessary to protect the thermometer from radiation by a screen. Its main purpose is to avoid direct short-wave radiation reaching the thermometer and to prevent the thermometer from precipitation, but allow ventilation. These contradictory criteria is a challenge to screen constructors. During the last 100 years improved compromises have been found between ventilation and protection.

In practise the constructors have solved the problem in the following way:

- The effect of absorption of short wave radiation at roof and walls are brought to a minimum by the use of white, reflective paint. Frequent maintenance is important to avoid increased absorption by dirt and bad painting (Andersson & Mattisson, 1991).
- Ventilation is optimised to prevent overheating by making the screens louvered (modern screens also double louvered). The louvers, however, may be a problem at high latitudes where a large proportion of the radiation reaches the walls at large angles and may penetrate to the thermometer bulb inside the screen.
- Reflection of short wave radiation from the ground is minimised for modern screens by a floor (often double). This is especially important when snow covers the ground in spring.
- Long-wave radiation exchange between the thermometer bulb and the ground is also prevented by the floor. Without a floor, heat loss from the bulb would have been especially large under inversions, when a steep temperature gradient near the ground often exists.
- The outer roof and walls should prevent precipitation from reaching the thermometer bulb. Otherwise it may lose heat by evaporation especially some time after the precipitation has stopped. This condition is not always fulfilled in strong wind. Drifting snow make measurements especially vulnerable in cold climate. Consequently, Iceland and Norway have designed a special screen for harsh climatic conditions where ventilation is somewhat reduced in favour of protection.
- The inertia of the screens should be brought to a minimum. This demand has been impossible to fulfil for the large wooden free-standing screens. On the other hand, small modern screens and sensors follow the air temperature so rapidly that temperature fluctuations on a time scale of seconds are measured. To ensure representative values on a somewhat larger time-scale it is recommended by WMO (1990) that synoptic air temperature (so called «now value») should be the mean value of several readings within a minute, e.g. in Norway 11 readings are used.

Experience has shown that screen errors appear most frequently at daytime under clear sky and calm wind, when temperature inside the screen may rise higher than «true» air temperature. Contrary, during clear, calm nights screen temperature may be slightly lower. The errors will probably be in the interval of -0.5°C to $+2.5^{\circ}\text{C}$ (WMO, 1983).

2.2 The main types of screens

In various countries three main types of screens are or have been widely used:

- Wall screens ; small cages fastened to a house wall, Fig. 2.4-2.6.
- Free-standing screens; wooden screens placed on grass fields, often called Stevenson screens after one of the constructors, Fig. 2.7-2.11.
- Sensor screens; small cylindrical free-standing screens built for automatic scanning sensors, Fig. 2.12-2.14.

The terms used in this article are underlined.

A change from wall screens to free-standing screens has taken place at most of the stations, and in recent years some of the old free-standing screens are replaced by sensor screens in connection with automation. Today the station network in the Nordic countries is a mixture of manual and automatic stations. At some stations the free-standing screens are maintained for homogeneity reasons through automation, but at a large number of automatic stations the more cost effective sensor screen is used as a stand-alone-screen.

Wall screen. According to instructions the wall screens should be placed on walls in shadow at all hours of observation. In flat open terrain in the Nordic countries it was not possible to find a wall which was permanently shaded throughout the year. If the station was situated in a southward slope, required shadow might have been provided. Also obstacles, as trees and buildings, might have provided sufficient shadow.

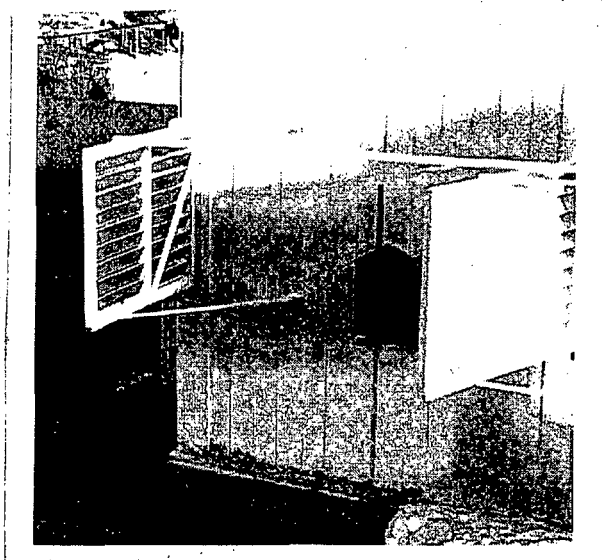

Fig. 2.1 At some stations extra screens were mounted to protect the cages from direct sunshine. This yellow painted Norwegian cage designed in the early 1870s appears dark at the photo.

If not possible to find a wall permanently in shadow, outer screens could be mounted at the wall thus preventing direct sunshine at the cage, Fig. 2.1. This method was often used where

the sun's angle to the wall was small at observation hours. In other cases it was found necessary to use two screens at parallel walls so that one of them always was shaded. Normally these instructions were followed but from station history a few cases of violation are known, allowing the sun to shine at the cages.

Some cages had only three walls as they were designed for mounting outside a window. The observers were instructed to read the thermometers through the window glass. Other cages had four walls with front doors which enabled the thermometers to be read from outside. The cages were made of tin, zinc or wood; painted white or yellow. Some of their walls were louvered but not necessary all of them. It is important to note that the cages had no floors, allowing radiation exchange between ground and thermometer.

Some early cages were made of plates which were bent into a cylinder. In the cylinder there was a split allowing the thermometers to be read without opening the cage. In Sweden early types of the window screen were rather open constructions as the one in Fig. 2.2, used mainly at second order stations. In Finland some of the cages were equipped with ventilation apparatus. An overview of the cages used in various countries is given in table 2.1. They are described in more details in section 2.3, photos Fig.2.4-2.6.

Table 2.1 Wall screens used in the Nordic countries.

Country	Type of screen	Material	Number of louvered walls	Colour: W=white Y=yellow	Fig. No.	Period of use
Denmark	Window cage	Wood	3	W		1872 - 1905?
	Wall cage	Wood	4	W		1873 - 1959
	Double wall cage	Wood		W	2.4b	1874 - 1987
Finland	Radiation shield	Metal	-		2.2c	1844 - 1873
	Wall cage	Zinc			2.6b	1871-1930s
Iceland	Wall cage	Wood	1-3	W*		1872 - 1964
	Wall cage	Metal		W*		? - 1950s
Norway	Open frame	Metal	-			Start - 1860s
	Box	Wood	4 (3)			1860s - 1875
	Cylinder	Tin	0			? - 1920s
	Box	Tin	2	Y or W	2.5	1875 - 1920s
Sweden	Open shelter	Metal	-	W	2.2ab	? - 1880
	Box	**	2	W	2.4a	1890s - 1930s

* Quite often the white colour was mainly nominal because of a lack of maintenance

** The material was metal, wood, or metal and wood.

The free-standing screen is normally a wooden cage located to a grass field at some distance from buildings or other obstacles. This type of screen is often called Stevenson screen although the constructor Thomas Stevenson's main contribution to screen design was the double louvered walls only (Andersson & Mattisson, 1991). This feature, however, was an important improvement of the screens.

Stevenson's oldest screen, referred to by Buchan in his Fig. 15 and 16 (Buchan, 1868), has double louvered walls 2 cm apart (Langlo, 1947), so that a ventilation channel is established between them. In the newer Stevenson screen the double louvered walls are set closer together. There are also major construction differences in roof and floor. While the new one has double roof and a floor, the old one has single roof and no floor (Føyn, 1915).

Another early designer of screens was H. Wild whose construction of 1874 came in widely use in Russia and Germany, and with some modifications also in Finland. It consisted of a roof over two concentric cylinders separated by an air space. The material was enamelled white zinc. Between observations the cylinders were closed but could be opened before the reading of the thermometers (Mawley, 1897). The screen could be placed at a north facing wall but was also designed for a set up inside a wooden single louvered free-standing screen.

The national institutes in the Nordic countries made their own screens, mostly after the model of the Stevenson screen. Often several modifications were made, especially in Norway they were comprehensive and therefore the newer screens should probably not be called «Stevenson screens». The different patterns of free-standing screens in Nordic countries are listed in table 2.2, photos in Fig. 2.7 - 2.11. Photos of screens in current use about 1970 are shown by Sparks (1972), about 75 countries are represented in his collection.

Table 2.2 Free-standing screens used in the Nordic countries.

Country	Name of the screen	Double Walls	Double Roof	Floor	Fig. No.	Period of use
Denmark	Horseshoe shelter	Open	No	No	2.3b	1860 - 1895?
	Fuess 1911, copy					1913 -
	Design from 1940s	Yes	Yes	Yes	2.9ab	1940s - in use
	Pattern of 1971	Yes	Yes	Yes	2.9c	1971 - in use
Iceland	Icelandic screen	Yes	Yes	Yes	2.11a	1951 - in use
Finland	Wild, ventilated	No	No	No	2.7a	1882 - 1922
	Wild, unventilated	No	No	No	2.7a	1890 - 1910s
	English screen	Yes	Yes	Yes	2.10a	1910s - in use
Norway	Norwegian Screen	Yes	Yes	Yes	2.8a	1895 - 1940s
	Edlund Screen	No	?	Yes	2.8b	1920 - 1940s
	Pattern of 1930 (MI-30)	No	Yes	Yes	2.8c	1930 - 1950s
	Pattern of 1933 (MI-33)	Yes	Yes	Yes	2.11b	1933 - in use
	Pattern of 1946 (MI-46)	Yes	Yes	Yes	2.10b	1946 - in use
Sweden	Open shelter	Open	-		2.3a	1880 - 1930/60
	SMHI, lighthouses	No	No?	Yes	2.7.b	1880 - 1930/50
	SMHI	Yes	Yes	Yes	2.10c	1920/1960 - i.u.

Sensor screen. Traditional screens contain several types of rather large manual instruments as thermometer, hygrometers and even thermo- and hygrographs. Automatic sensors may be run almost continuously thus one temperature sensor may replace the main thermometer, the two extreme thermometers as well as the thermograph. Fewer number of sensors which need to be screened and the smaller size of modern sensors have made it more cost effective to construct small separated radiation screens designed for each sensor.

The screens used in the Nordic countries have cylindrical forms built of concentric rings with a space for ventilation between them. Thus, they are louvered like earlier screens, some of them even double louvered. The outside facing surface is white in order to reflect as much as possible of the radiation and on many screens the inner surface is painted black in order to absorb rest radiation before reaching the sensors. The material may be electroplated aluminium or several sorts of plastic. The screens presently used in the Nordic countries are listed in table 2.3, photos and illustrations Fig. 2.12 - 2.14.

Table 2.3 Sensor screens used in the Nordic countries.

Country	Type of screen	Double louvers	Material	Inside colour	Fig. No.	Introduction of sensor screens
Denmark	Aanderaa	No	Plastic	Black	2.12	1978
Finland	Vaisala DTR 13	No	Plastic	Black	2.13	1970s
Iceland						1980s
Norway	Pattern of 1974 (MI-74)	Yes	Plastic	White	2.14a	1975
Sweden	Vaisala DTR 13	No	Plastic	Black	2.13	Mainly 1995

2.3 Description of screens used in each country

As a part of the NACD project first hand sources, especially inspection reports have been studied. They contain information of instrumentation at the stations hardly available to the outside world because of its hugeness, the use of national languages and restrictions for lending. Early temperature exposures are, however, listed country by country by Parker (1992). His descriptions are limited by the availability of published documentation. Thus the material from the institute's archives has made a more complete description possible.

Denmark

The temperature exposures before the start of regular systematic observations in 1873 will not be described here, except for one station. The longest series of temperature measurements in Copenhagen starts in 1751, and has since 1860 been located at the Royal Veterinarian and Agricultural University. The open horseshoe shaped temperature screen at this station has been illustrated in Fig. 2.3b (after Brandt, 1994).

From the start of the Danish Meteorological Institute in 1873, the main climatological stations were equipped with single louvered wall screens, of which 3 were placed on north-facing windows, following recommendations by Mohn (1872). The remaining screens were placed on north-facing walls. Occasional problems with direct sunshine on the screens were fixed locally by putting up additional screens to the east and west of the louvered wall screens. In Greenland, several louvered wall screens were mounted on wooden double fences, as shown in Fig. 2.6a.

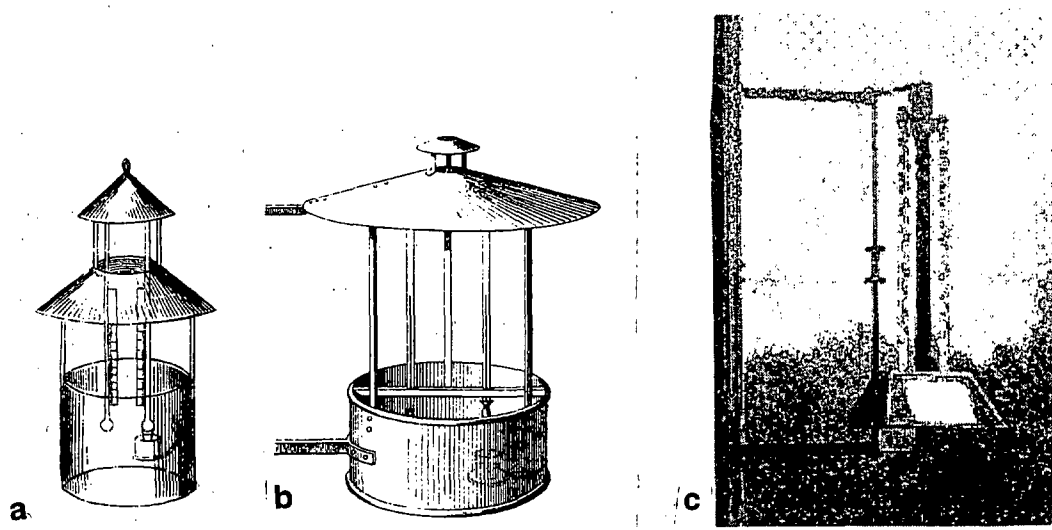

Fig. 2.2 Window shelters.

a) Swedish shelter described by Edlund (1858). After Kreil (1848).

b) Swedish shelter described by Edlund & Hamberg (1882).

c) Finnish radiation shield used in Helsinki, 07.1844 - 08.1882 (Johansson, 1906).

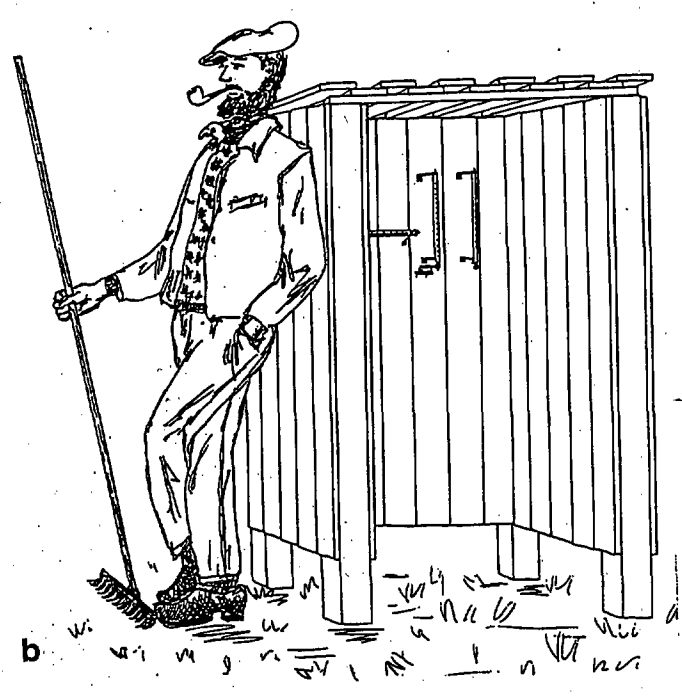
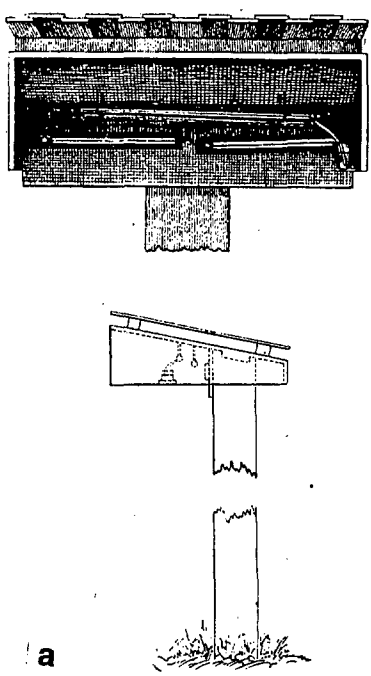
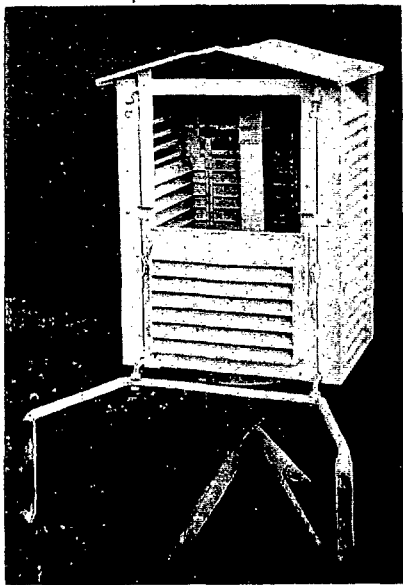

Fig. 2.3 Free-standing shelters.

a) Swedish shelter mainly used at third order stations. After Edlund & Hamberg (1982).

b) Reconstruction of Danish open shelter at Landbohøjskolen. The roof is obviously not like the description (DMI, 1876) (Brandt, 1994).



a

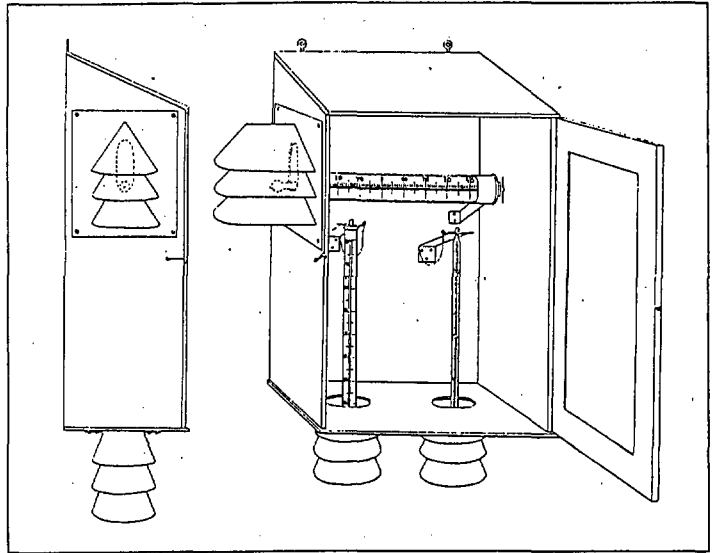

b

Fig. 2.4 Wall screens.

a) Swedish window screen of the type introduced at land stations in the late 1890s.

b) Danish «double» thermometer cage with minimum, vertical maximum and dry bulb thermometers. (DMI, 1874).

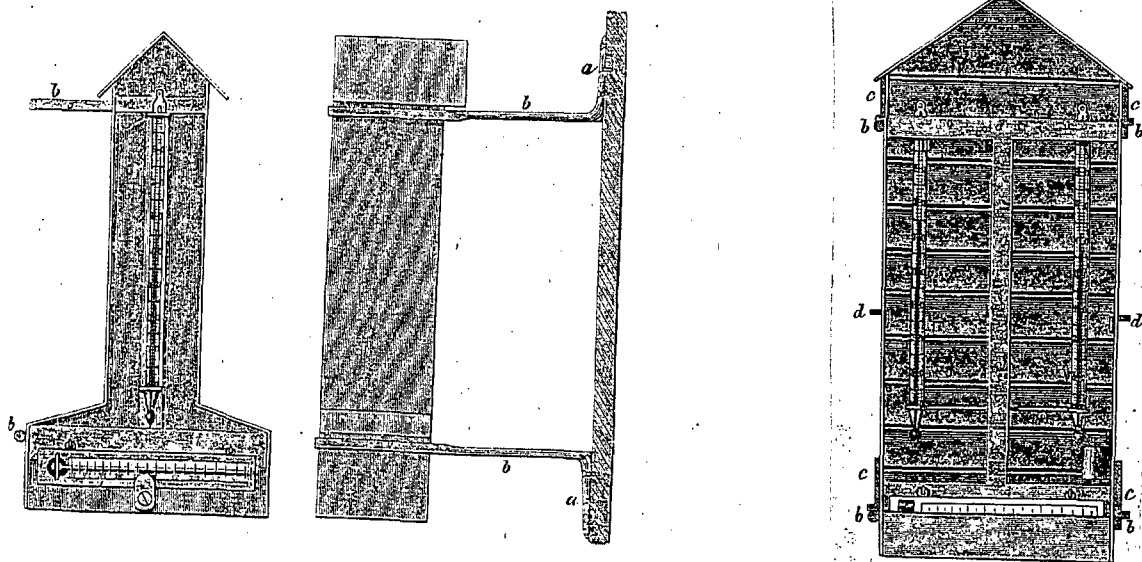
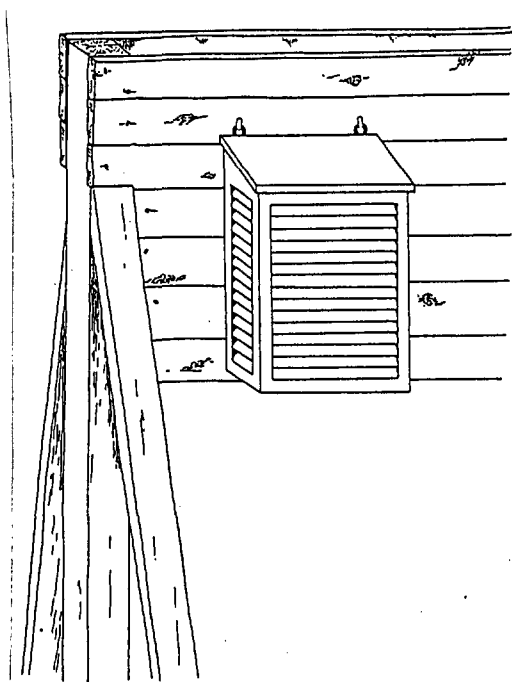
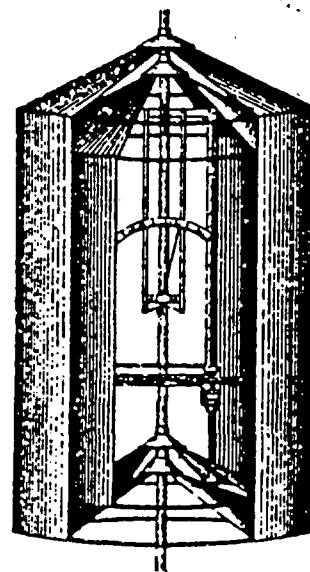

Fig. 2.5 Norwegian wall screen designed in the early 1870s (DNMI, 1888).



a



b

Fig. 2.6. Wall screens.

a) In Greenland, several louvered wall screens were mounted on wooden double-fences (Brandt, 1994). Some of these screens were in continuous use from 1873 to the 1960s. Local repair and new paint have although changed their efficiency over the period of use.

b) Wild's cylindrical cage used in Finland from 1871 until the early 1900s (Heino, 1994).

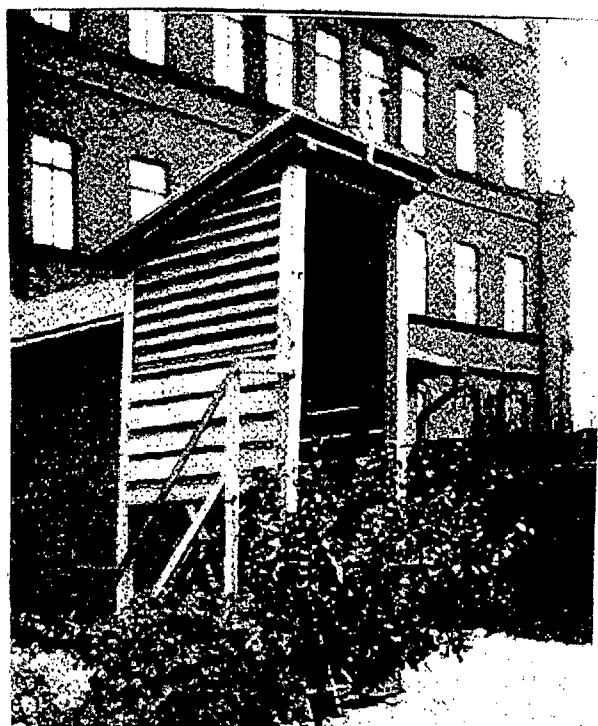

a

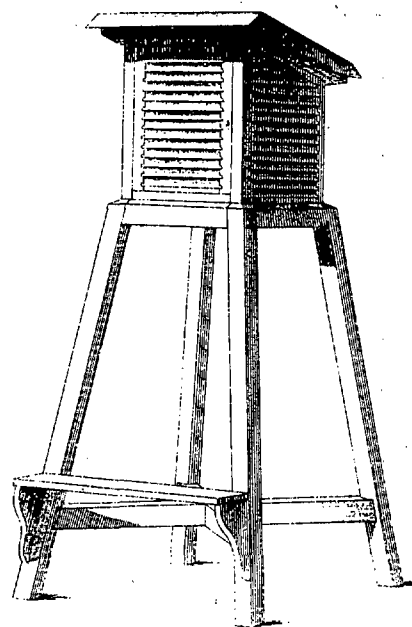

b

Fig. 2.7 Single louvered free-standing screens.

a) Russian Wild's screen used in Finland from 1882 until the 1910-20s (Johansson, 1906)

b) Swedish Stevenson screen used at lighthouse stations as early as the nineteenth century. (After Nautisk Meteorologiska Byrån, 1879) (Andersson, 1970).



a

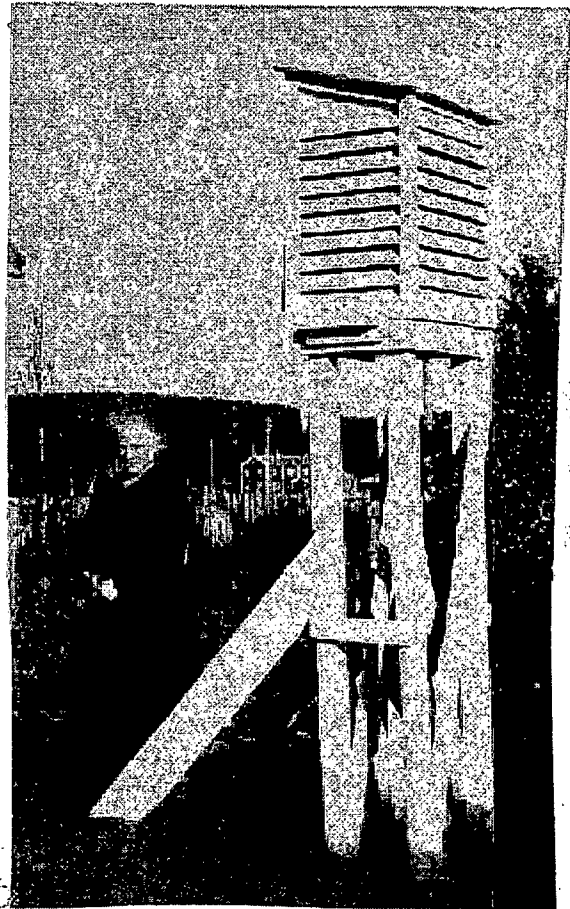

b

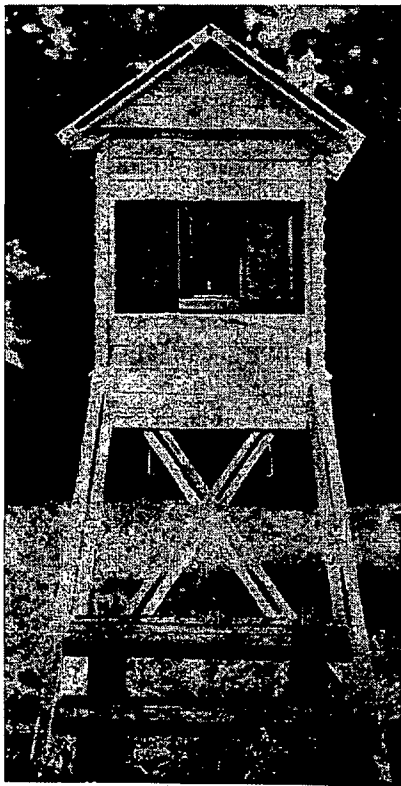

c



c

Fig. 2.8. Outdated free-standing screens used in Norway.
a) The «Norwegian screen», double louvered, photo from Bergen - Fredriksberg (Føyn, 1915).
b) Edlund screen, single louvered, photo from Karasjok in an inspection report.
c) Pattern of 1930 (MI-30), single louvered with an internal metal cage (DNMI, 1937).

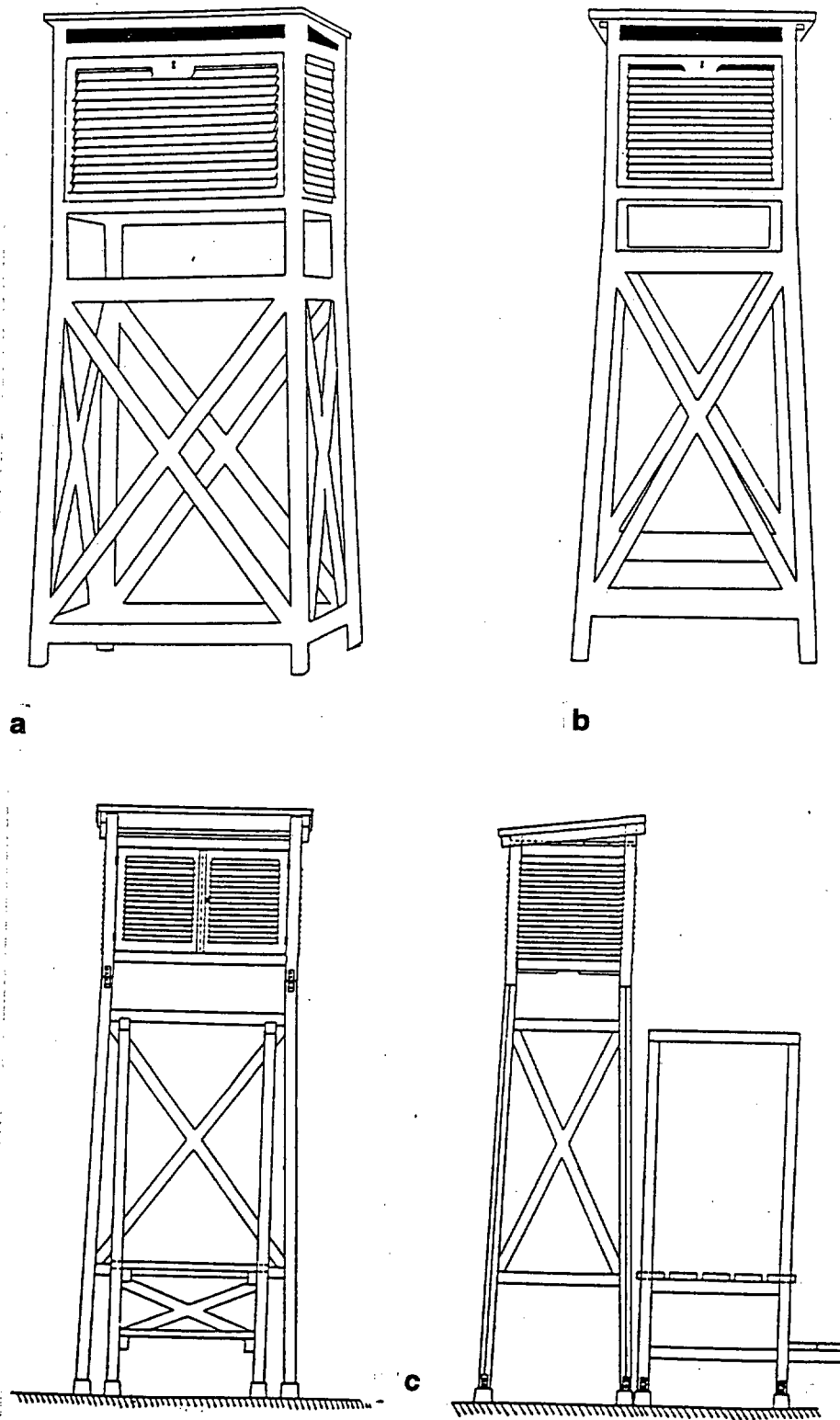
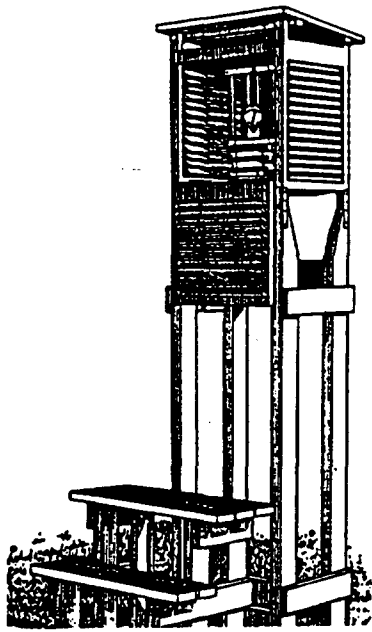
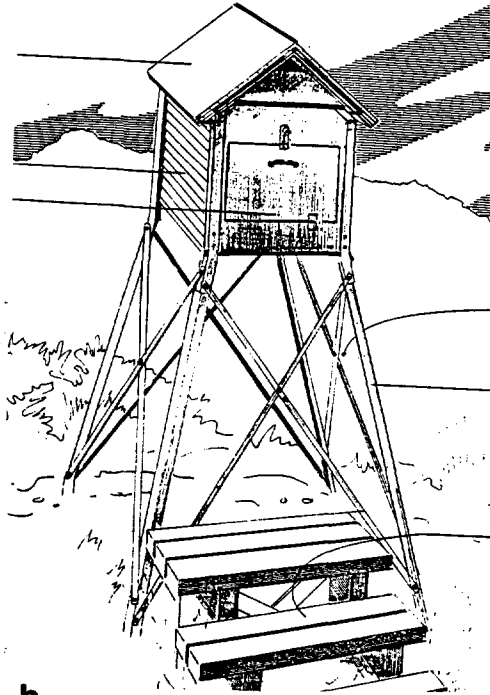

Fig. 2.9. Double louvered free-standing screens used in Denmark.
 a) and b) Two Stevenson screens of various size erected after World War 2. The sketches are based upon photos (Brandt, 1994).
 c) Stevenson screen, pattern of 1971. (Brandt, 1994).



a



b

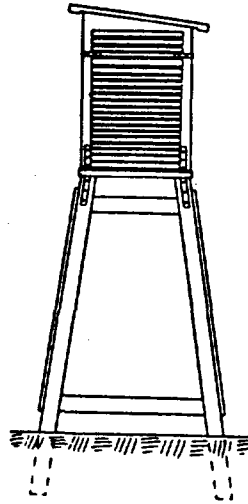
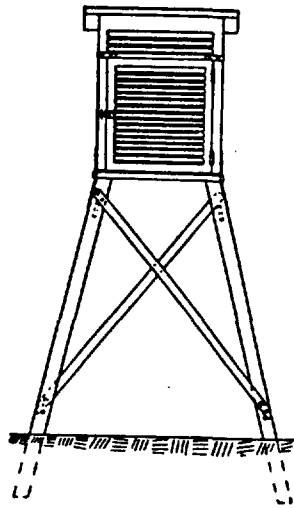

c

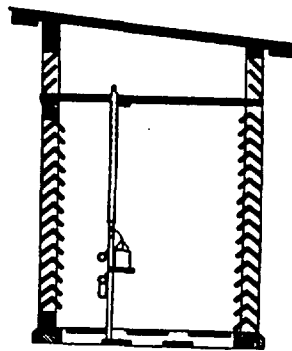
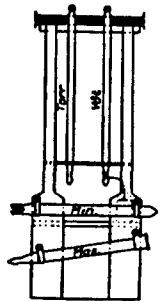
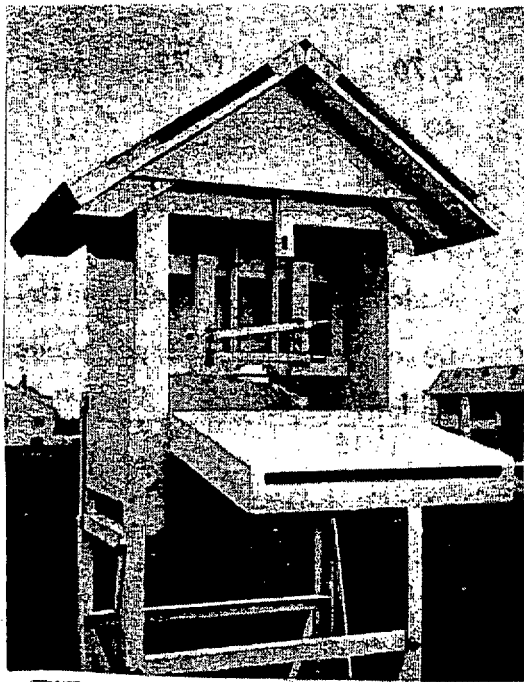
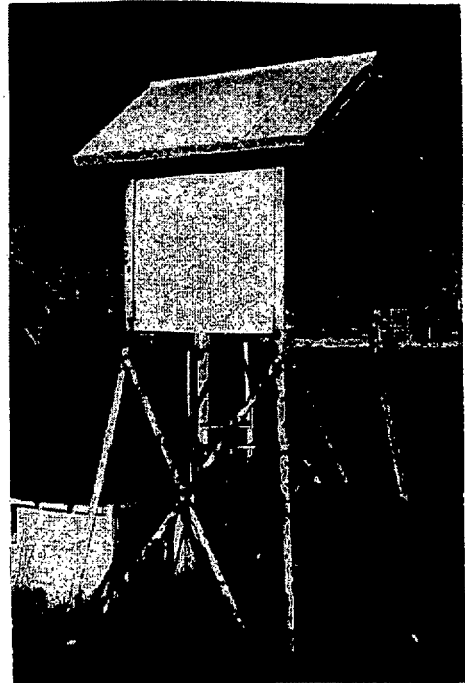

Fig. 2.10. Double louvered free-standing screens in current use.

a) Finnish «English» Stevenson screen. b) Norwegian pattern of 1946 (MI-46). c) The SMHI screen.



a



b

Fig. 2.11 Free-standing screens with solid double walls constructed for harsh weather conditions. a) Icelandic screen model VI. Photo from Sparks (1972). b) Norwegian pattern of 1933 (MI-33). Dimensions of the two screens are different, but otherwise the screens are similar.

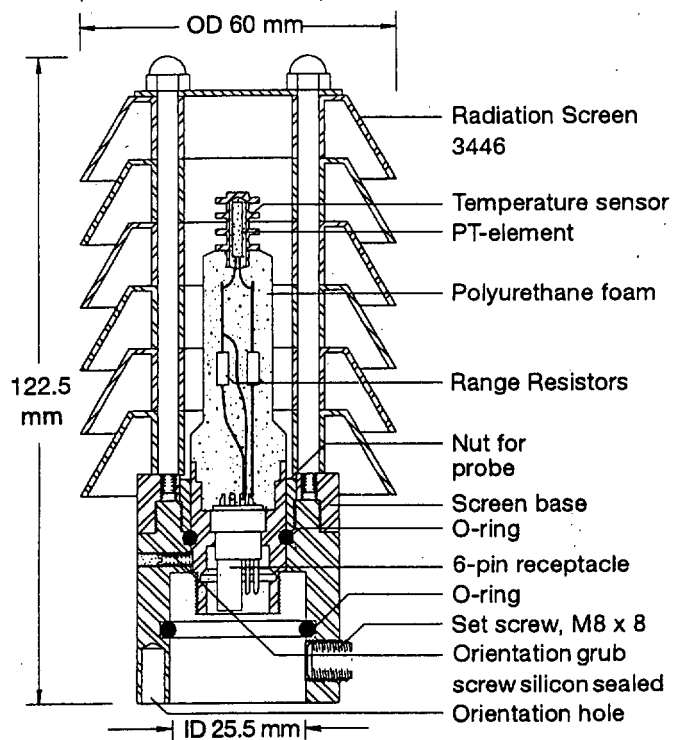
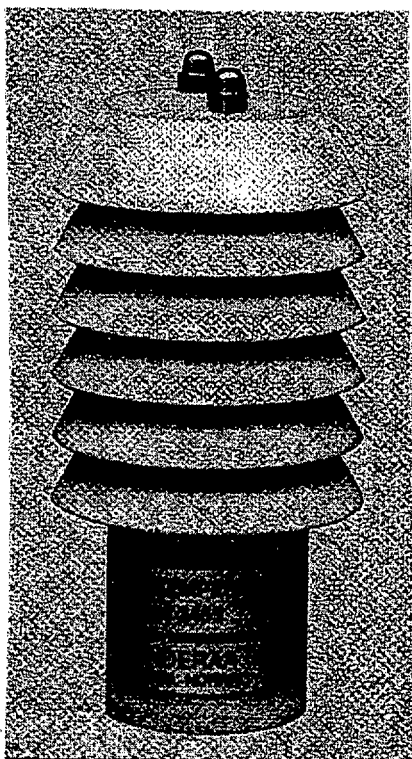

Fig. 2.12 Sensor screen of Aanderaa type used in Denmark.

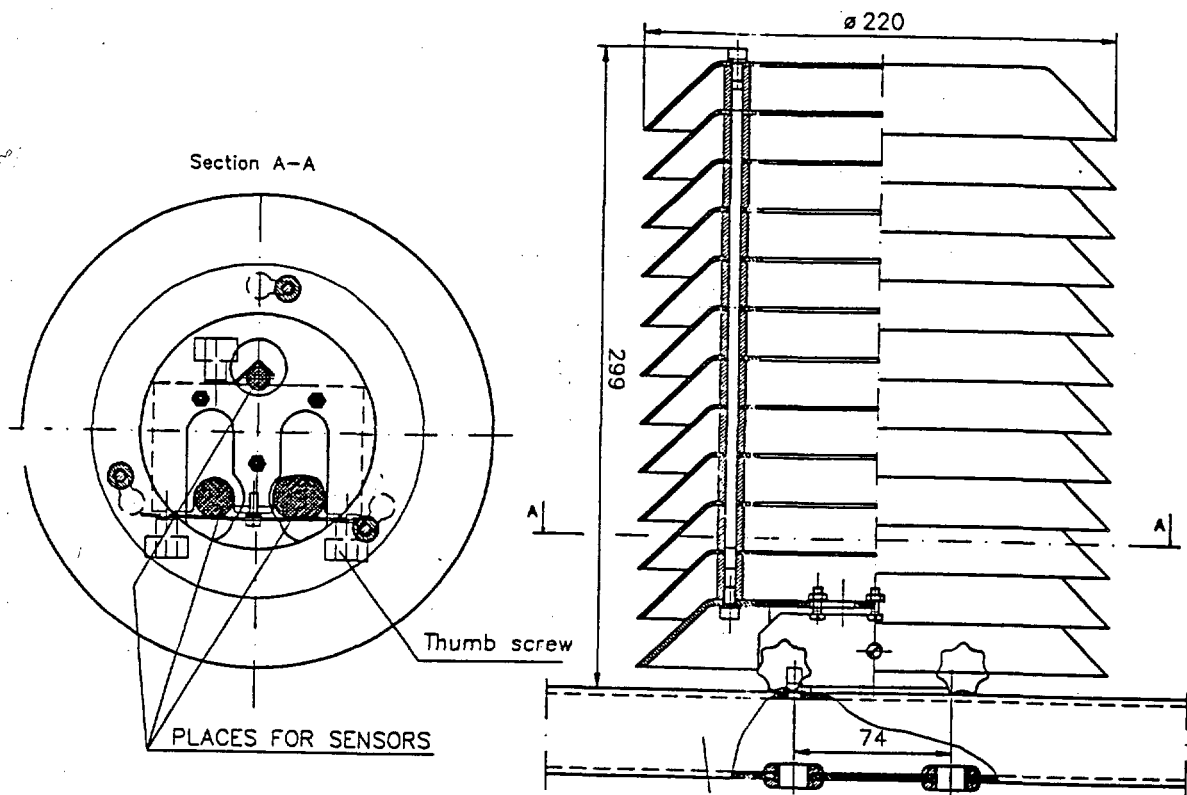

Fig. 2.13 Vaisala sensor screen, type DTR 13, in current use in Finland.

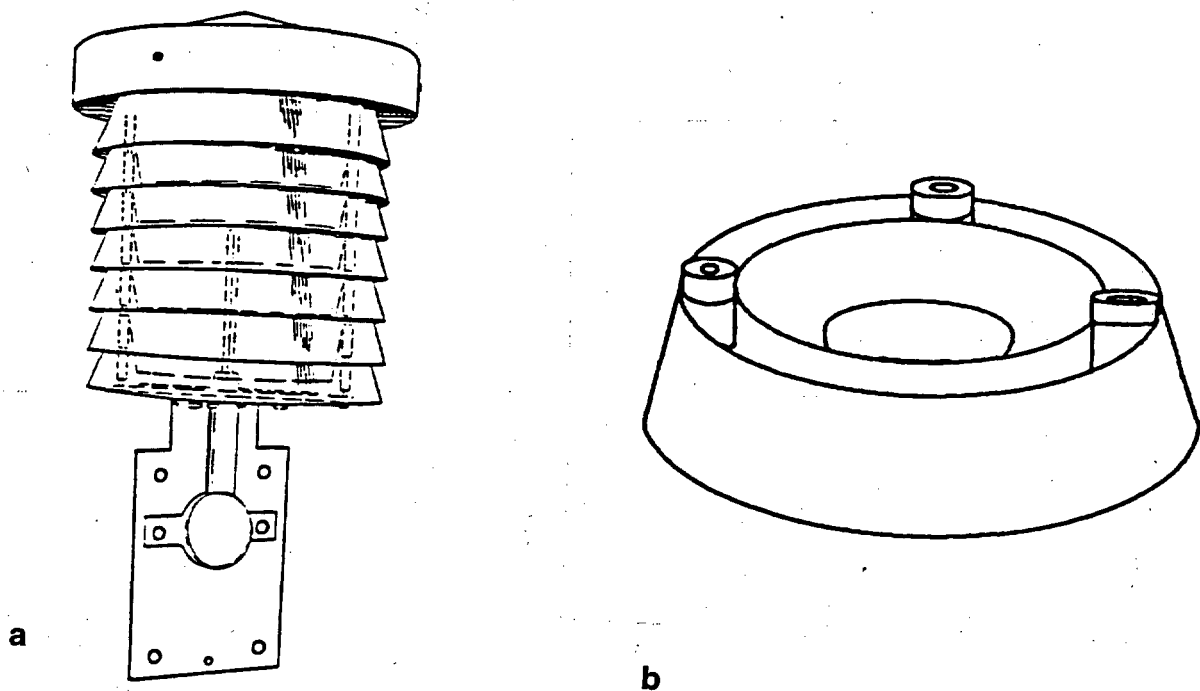

Fig. 2.14 Norwegian pattern of 1974 (MI-74), sensor screen in current use.

a) The screen seen from outside.

b) The screen is double louvered, consisting of inner and outer plastic rings fixed at three vertical bars. A pair of those rings is shown in the figure. (Drawing by Leif Gunnar Olonkin).

By the middle of the 1870s, a new type of wall cage was introduced, mainly at secondary climatological stations. This type of cage was also mounted on north-facing walls, but the screens were not louvered. Instead they had holes in the bottom and side, with three metal screens covering the thermometer bulbs, which were actually outside the cage. From about 1878 until about 1920, many of the stations in Greenland, Iceland, the Faeroes and Denmark were equipped with single cages (for vertical maximum thermometers) and/or double cages with two holes in the bottom and one or two holes in the side. The wall cages were widely used for about 40 years, and some stations even had wall cages until the middle of the 1980s. The double wall cage is illustrated in Fig. 2.4b.

Beginning about 1911, the primary climatological stations were gradually equipped with free-standing Stevenson screens, built in Denmark as a copy of a 1911 Fuess screen. Later on this small Stevenson screen was replaced by a larger model. It is not known when this larger model was introduced, but generally the major part of the stations in the NACD network got Stevenson screens during the period 1913 - 1928. The three types of Stevenson screens used by DMI is illustrated in Fig. 2.9.

During the period 1978 to 1987, a number of automatic weather stations replaced the various manual stations. The temperature sensors have generally been located in the existent Stevenson screens, but over the past few years, the Aanderaa thermometer screens have been used alone at many locations (see Fig. 2.12a).

Finland

The early temperature measurements in Helsinki, Fig. 2.2c, were actually not done inside a shelter. Four thermometers were fastened outside windows on each side of the building and the thermometer in shade was read. The thermometer bulb was protected against short wave radiation.

After 1871 the other climatic stations were equipped with cages made of zinc plate to shelter the thermometers from rain and solar radiation, Fig. 2.6b. They were mounted on shaded walls of buildings. Some of the cages also contained a ventilation apparatus.

In August 1882 the first free-standing screen, a modification of a Russian Wild-screen, Fig. 2.7a, was installed in Helsinki. The zinc cage, Fig. 2.6b, was mounted inside the Wild-screen. During the 1890s the number of Wild-screens increased, while most lighthouse stations were equipped with the zinc cages in 1894-95. The zinc cages were in use at some lighthouse stations until the 1940s.

The present screen type, Fig. 2.10a, a modification of the Stevenson screen was installed at ordinary climatic stations between 1909 and 1912, at Helsinki in 1923. It is still in use at all manual stations.

The first automated stations with sensor screens were installed in the 1970s. The number increased steadily during the 1980s. The tendency of this decade has been to replace some of the old manual stations with automatic stations. The sensor screen used in Finland is the Vaisala DTR 13 type, Fig. 2.13, which is very similar to the Vaisala screen tested at Norrköping, Ch. 6.

A more comprehensive history of Finnish screens is available in Heino (1994).

Iceland

Before 1920 Danish screens were in use in Iceland. The Icelandic wall screens that gradually replaced the Danish ones were much similar to these. Before the second world war the maintenance of the stations was minimal and the condition of the screens was very variable and left much to be desired.

During the war years the occupying forces brought new screens to a few stations. These were of an English (large or modified Stevenson) type. During a few years around 1950 Norwegian screens were used at a few stations, but use of wall screens was the rule. During 1951-1964 the older types were all replaced by a new type free-standing screen of a special design (VI), Fig. 2.11a, but most similar to the Norwegian MI-33, i.e without louvered walls, but slightly smaller (Sparks, 1972). The choice of design reflects the problem of penetrating snow and rain so prevalent at the more exposed Icelandic locations.

The actual coating material of the VI-screen has been variable. During the first part of the period the wood in the roof was coated with water-repellent canvas, later zinc coating was used and recently one did revert to roofs made out of plastic.

Norway

In 1860 the screen consisted of a frame with brackets for fastening of the thermometer and the screen itself to a north facing wall or window. The only shelter for the thermometer mentioned in «Guidance Notes on performing Meteorological observations» (Nielsen, 1860), was a roof over the frame. In the text there are detailed instructions for how to dry the thermometer before observation. This leads to the conclusion that the construction has been widely open. This early shelter must have been replaced by a cage already in the following years. In the new guidance notes from 1867 it is stated that a cage protected the thermometers from "sunshine, rain, snow and wind without preventing the air from passing through" (DNMI, 1867).

According to Gorczynski (1910), quoted by Parker (1992) Wild's cylindrical zinc screen was recommended by DNMI in 1871 (DNMI, 1871). Reading the text in the original language, only the recommendation of window screens is confirmed (for practical reasons), not the material or cylindrical form. The cage was actually made of wood and its walls were louvered (DNMI, 1874).

Cylindrical screens were, however, in use at the lighthouse stations. The construction was not so open as the ones mentioned in 1860. They had roof and walls, but no floor. The side wall was made by a tin plate bent almost together except for a split through which the thermometer was ably read through a window or from outside the house (DNMI, 1875). It is documented that this screen has also been used at an inland station, Karasjok, near the Finnish border (Høgåsen, 1996).

In 1875 the wooden cage was replaced by a new type made of tin with the following dimensions: height: 59 cm, width: 25 cm and depth: 19 cm, somewhat larger than the previous one (DNMI, 1875). On all screens the front wall was louvered, the two small side walls consisted on the contrary of solid plates. Used at a window the back side was open, used at a

wall it was louvered, Fig. 2.5. The cage had no floor. It is important to note that these new cages did not replace the cylindrical ones at the lighthouse stations.

The first free-standing screen was introduced in Norway in 1877. It was a Wild's screen at Oslo Observatory. The first «Norwegian Screen», Fig. 2.8a, was designed in 1895 (Føyn, 1915), after the model of the old Stevenson screen, or more precisely the figures 15 and 16 in Buchan's «Handy Book of Meteorology» (Buchan, 1868), which contains drawings of the screen. Taking into account the rather crude figures in the book and several improvements made by the institute (i.e double roof and floor, Føyn op.cit.), the Norwegian Screen was far from an exact copy of its original.

In 1920 a free-standing screen was built at the Geophysical Institute in Tromsø. The screen is popularly called Edlund Screen, Fig. 2.8b, after the designer O. Edlund. This screen has 4 single louvered walls and a flat sloping roof (Langlo, 1947). Inspection reports show that this screen was in use only in the northern part of the country.

Neither the Norwegian Screen nor the Edlund Screen came into widely use; in the 1920s, the window screens were still predominant. However, during few years in the beginning of the 1930s the newly designed free-standing screens of patterns 1930 (MI-30), Fig. 2.8c, and 1933 (MI-33), Fig. 2.11b, replaced the wall screens. The pattern of 1930 was constructed according to the Wild's principle allowing a window screen to stand inside a free-standing wooden shelter. The inner screen used was the window screen designed just before 1875.

The pattern of 1933 is constructed for harsh weather conditions. The walls are double but they are not louvered which to a certain extent prevents drifting snow to penetrate into the cage. The screen is still in use at high mountain or lighthouse stations. Today the most common screen is the pattern of 1946 (MI-46), which is similar to the MI-33 except from the two louvered side walls, Fig. 2.10b.

At most stations older than 1930 the equipment changed from wall screen via MI-30 to MI-33 or to MI-46 depending on local climatic conditions. The few stations equipped with the Norwegian or Edlund screens changed directly to MI-33 or MI-46.

Sweden

The early types of screen were white-painted metal window shelters, Fig. 2.2a and b). They were used up to around 1880 at smaller stations and then replaced by the free-standing shelters, Fig. 2.3a. At major stations they were replaced in the late 1890s when a new type of window screen was introduced, Fig. 2.4a.

Later types of white window screens of wood and metal were mainly used at major stations from the late 1890s to 1930-1940 when they were replaced by free-standing screens of the Stevenson type. At Stockholm Observatory a window screen was in function until the end of 1960.

The free-standing white wooden shelter, Fig. 2.3a, was mainly used at smaller stations from about 1880 to 1930-1960 when it was replaced gradually by Stevenson screens.

Free-standing screen of Stevenson type was introduced already from about 1880 at lighthouse stations. It was made of wood, painted white and had single louvers. At inland stations Stevenson screens with double louvers (we have found no evidence of single louvers in earlier years at inland sites but no original screens have yet been found or documented in that detail) gradually replaced the older screen types. At major land stations it was introduced mainly in the 1930s, while smaller stations got a Stevenson screen usually within the period 1930-1960. At lighthouses the old screens (Fig 2.7.b) were also gradually replaced by the newer type (Fig 2.10 c), mainly during 1930-50.

Also a smaller version of the SMHI Stevenson screen is used at some stations.

A small free-standing plastic screen, Fig. 2.13, is used to protect the small sensors (mainly platinum resistance thermometers) in automatic station set-ups mainly from 1995 when a large programme for reduction of observational costs was undertaken.

3 Test results of free-standing screens compared to ventilated thermometers

In test fields ventilated thermometers often were used as a measure of «true» air temperature, e.g. a psychrometer of Assmann type. This instrument has less inertia and consequently reveals greater fluctuations in temperature than free-standing screens. The different inertia leads to greater standard deviations of the difference but not to biases in its daily mean values. Standard deviation may be reduced by taking a mean of more than one reading of the ventilated thermometer (Langlo, 1947). A more serious problem is that ventilation draws up air from lower layers which may be cooler or warmer than the air at the measuring level. Unfortunately it can not be excluded that this may cause biases in the mean values of the differences. In spite of the just mentioned disadvantages of ventilated thermometers, they establish the best common reference temperature available for comparison of test results from various sites.

Table 3.1. Monthly mean differences (in 0.01°C): Temperature of forced ventilated air minus temperature in free-standing screens.

Country /Screen	Test	Jan	Feb	Mar	Apr	May	Jun	Jul	Aug	Sep	Oct	Nov	Dec	Yr
Finland														
Wild, ventilated	1	-2	-5	-11	-18	-30	-37	-37	-23	-9	-3	0	2	-14
English screen	2	8	7	6	3	-4	-12	-11	0	6	6	7	8	-2
Norway														
Norw. Screen*	3	6	-3	-6	-6	-15	-21	-26	-16	-9	-4	0	-5	-9
MI-30*	4	-5	-1	-5	-15	-21	-33	-36	-34	-16	3	-4	5	-13
MI-33*	4	-8	-4	-4	0	7	-12	-13	-10	-7	3	-4	-3	-5
MI-33*	5	3	2	-1	-6	-31	-16	-26	-18	-10	6	6	9	-7
MI-33*	6						-12	-12	-8	-18				
MI-46*	5	5	1	1	4	-18	6	-3	-2	5	6	7	11	-2
Sweden														
SMHI-large	7	2	2		-1	-1	-2	6	-1	0	0	-2	-1	0
SMHI-small	7	0	0		-5	-5	-8	1	-4	-2	-2	-4	-3	-3

Note:

* The minimum temperature term in the formula of monthly mean temperature (formula (26) in appendix II) is omitted. This will add an additional uncertainty to the results of 0.1°C or less.

Tests:

1. Helsinki (60°10'N, 24°57'E) Southern Finland. Period: 1898 - 1904. (Johansson, 1906).
2. Helsinki (60°10'N, 24°57'E) Southern Finland. Period: 1923 - 1946, altogether 8766 daily observations. (Heino, 1994). Average differences are calculated by formula (16), Appendix II.
3. Bergen (60°24'N, 5°19'E), Fredriksberg Observatory, Western Norway. Period: 1911.03 - 1912.03. (Føyn, 1915).
4. Ås Observatory (59°41'N, 10°47'E), South-Eastern Norway. Period: 1938.02 - 1939.01. (Langlo, 1947).
5. Oslo (59°55'N, 10°43'E), Norwegian Meteorological Institute, South-Eastern Norway. Period: 1946.06 - 1947.05. (Langlo, 1947).
6. Kleppe (60°31'N, 5°33'E) on Osterøya, Western Norway. Period: 1952.06 - 1954.09. Data comprises the season June to September only. (Utaaker, 1956).
7. Norrköping (58°58'N, 16°15'E), Central Sweden, Swedish Meteorological and Hydrological Institute Period: 1989.04 - 1990.02. (Andersson & Mattisson, 1991).

Comparisons have been made at fixed clock hours, often at the same hours as the ordinary observations. In literature average temperature differences from these comparisons are available, but usually not monthly average differences representative for the whole day. As our main concern is possible inhomogeneities in mean temperature time series, the average temperature differences should also be calculated. If the formulas for mean monthly temperature are linear, the calculation of the monthly differences can be done by simply replacing clock mean temperatures by clock mean temperature differences. Almost all formulas used in the Nordic countries are in fact linear, Appendix II. In table 3.1 differences in mean monthly temperature in ventilated air and in screens obtained over a rather long time span are presented, see notes underneath the table.

Some authors have calculated the level of significance of the mean monthly differences by Student's t-test on the basis of the standard deviation of individual differences and the number of observations. With 3 observations a day during a month, highly significant mean differences are obtained if their magnitude is $0,1^{\circ}\text{C}$ or more. In many cases mean differences as small as 0.05°C are significant, which is of the same magnitude as the error of well calibrated thermometers.

In the Helsinki series (test 2 in table 3.1) the standard deviation of the monthly mean difference is calculated to values from 0.03°C (February) to 0.09°C (July) depending of the month. In other works, e.g. tests 3-5, the standard deviation of the monthly mean is calculated by dividing the standard deviations of individual differences by the square root of the number of observations involved. Then roughly the same values as in Helsinki are found.

The more scattered differences in summer than in other seasons are also shown in Fig. 3.1 for selected months.

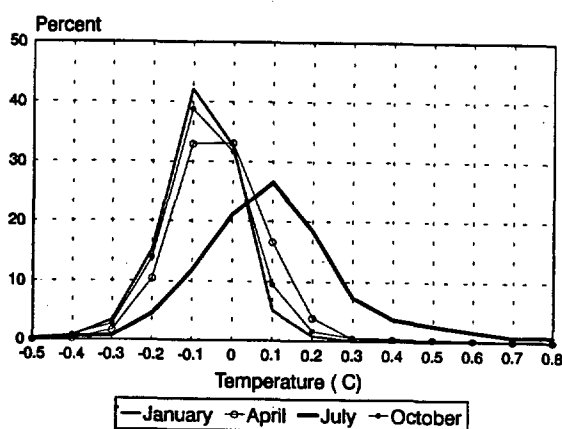

Fig. 3.1 Distribution of the differences between daily mean temperatures determined with Assmann psychrometer and ordinary thermometer readings in an English type screen in Helsinki 1923-1946. Based upon table 3.2 from Heino (1994).

For the Norwegian screen MI-33 two (at summer three) test series exist from different sites. The results differ as much as can be expected in most of the months taking into account the above values of standard deviation. An exception is May where the figures differ much more.

For all months except May the Norwegian standard screen MI-46 is subject to very little overheating compared to forced ventilated air, test 5 in table 3.1. In May, however, the sun's radiation reached the louvered walls at approximately vertical angles at morning and evening observations and may have penetrated into the cage. This is confirmed by the fact that the entire difference in May resulted from the morning and evening observations (not shown in the table). Similar overheating is not present in August, probably because of higher frequency of cloudiness. Overheating at low solar angles is also in agreement with measurements at Vågåmo (62°N , 9°W) (Høgåsen, pers. comm).

Similar results are also found by Andersson & Mattisson (1991), test 7, for two of the standard SMHI-screens. The largest overheating of the screens occurred around the time of sunset and, to a lesser degree, at sunrise. The large values at sunset can also be attributed to a back lag caused by the screens' inertia, but this will be levelled out when integrating to get the monthly mean temperature. The monthly mean differences of the SMHI screens are less than $0,1^{\circ}\text{C}$ at all months, table 3.1.

In figure 3.2 the test results are grouped mainly according to the shape of the screens' walls; single louvered, old double louvered, double louvered and double walls. In the season from October to March the monthly mean temperature from all groups follows the temperature measured in ventilated air very well, the differences being less than $0,1^{\circ}\text{C}$. This is true also for the individual test results (except for two values), table 3.1.

In the season May - September, however, the Norwegian MI-33 screen is overheated by $0,1 - 0,2^{\circ}\text{C}$, the result based upon comparison from three places around $60^{\circ}-61^{\circ}\text{N}$. This screen for harsh weather condition seems to be somewhat better than the old double louvered Norwegian Screen, Fig. 2.8a. In the months May - August the latter is overheated about 0.2°C , but for the rest of the year the differences are within an interval of $\pm 0.1^{\circ}\text{C}$. Greatest overheating during summer is as expected found for the group of single louvered screens whose overheating is at most $0,3 - 0.4^{\circ}\text{C}$ in June and July.

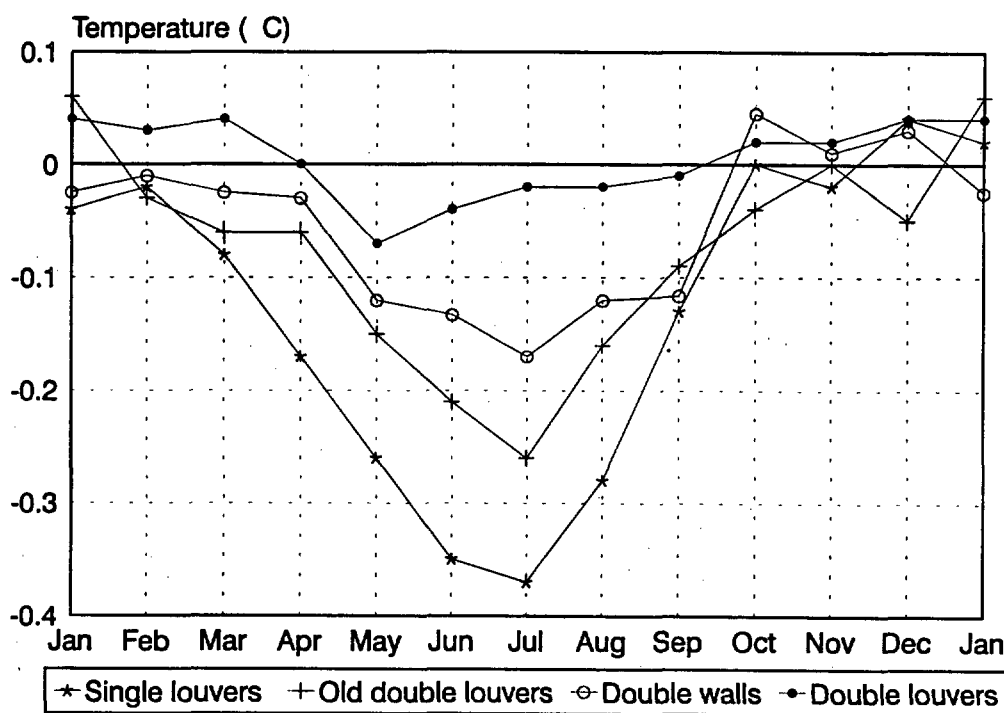

Fig. 3.2 Monthly mean differences between: Temperature of forced ventilated air minus temperature in ordinary free-standing screens. Mean values for three different group of screens, i.e:
Single louvers: Finnish Wild's screen and Norwegian pattern of 1930.
Old double louvers: Norwegian Screen
Double walls: Norwegian pattern of 1933.
Double louvers: «English» Screen used in Finland, Norwegian Pattern of 1946, Large and small SMHI-screens.

Mean monthly temperature differences for the group of double louvered screen are within an interval of $\pm 0,1^{\circ}\text{C}$ throughout the year. In this group the «English» Screen used in Finland has a small overheating of about $0,1^{\circ}\text{C}$ in June and July found for a very respectable period of comparison, 1923-46 comprising 8766 observations (Heino, 1994).

Summary and discussion Comparisons demonstrate that the free-standing screens have been improved during this century. Thus the screens on the last stage in the development follow the monthly mean temperature measured by ventilated thermometers very well at all months of the year while the old types of screens follow during winter only. The greatest overheating ($0,2 - 0,4^{\circ}\text{C}$) of the old types occur in the season May - August.

Most of the comparisons are performed at areas of continental climate; Bergen and Kleppe being the exceptions. For the MI-33 screen, test results from both maritime climate (Kleppe, test 6) and continental climate (Ås and Oslo, tests 4 and 5) are available. From table 3.1 it is seen that the results from Kleppe do not differ systematically from the those in Eastern Norway. Kleppe, however, is situated in a fjord district in Western Norway about 40 km from the shore. The overheating is expected to be less at coastal sites where calm, fair weather situations do not occur so frequently.

Direct use of the test results at other latitudes than around 60°N where comparisons are made is questionable. At high latitudes radiation reaches the louvered walls at greater angles than at the test sites and may easier penetrate into the inner of the screens.

4 Test results from nineteenth century screens or shelters achieved by parallel measurements

Test results from screens used in the nineteenth century seem to be rare in the Nordic countries probably because only few comparisons have been done. The reason may also be that some test results are lost. Three tests of nineteenth century screens, however, have come to our knowledge.

Copenhagen (55°41'N, 12°36'E), Denmark. During the period from 1874.11 to 1884.12 comparisons were made between a screened thermometer and a thermometer in «free air» at Danish Meteorological Institute which was situated at Toldboden (custom-house district). Unfortunately very little is known about the equipment used. Was the thermometer in free air completely without screening or was perhaps some kind of screening present, e.g. something like the open shelters in Fig 2.2 The type of screen of the «screened thermometer» is also unknown.

The thermometer in free air was fastened to a wall at second floor. Mean values of readings at 08^h, 14^h and 21^h are shown in table 4.1.

Table 4.1 Mean differences (in 0.01°C) between a thermometer in «free air» and a screened thermometer. Mean values of at 08^h, 14^h and 21^h observations at Danish Meteorological Institute in the period 1874.11 - 1884.12.

Jan	Feb	Mar	Apr	May	Jun	Jul	Aug	Sep	Oct	Nov	Dec	Year
-16	-22	-24	-29	-23	-21	-25	-28	-14	-12	-15	-13	-20

It is readily seen from the table that the thermometer in free air is the warmest one during the whole year, on the average 0.20°C warmer. During February - August the differences are higher than the annual mean whereas they are lower during September - January. If the sites of the thermometers have equal micro climate it may be concluded that the thermometer in «free air» is overheated.

Oslo (59°55'N, 10°43'E), Norway. Double measurements of two different types of wall screens have been carried out at DNMI during «a long series of comparison», before the institute changed their wall screens in 1875. Then metal boxes, Fig. 2.5, replaced somewhat smaller wooden boxes, Ch. 2.3. The original results from the comparison are not found, but the conclusions are known (DNMI, 1875). They are:

- Due to its lesser mass, the new metal cage followed rapid variations in air temperature more closely than the old one.
- For mean temperature no important differences between the cages were found.

Henstad (59°22'N, 13°23'E), outside Karlstad, Sweden. Seven years of measurements made on a flat meadow at Henstad are analysed (Modén, 1954). Two screens were used, the Stevenson free-standing screen and the free-standing shelter shown in Fig. 2.3a. The free-standing shelter was open from below and no doubt gave too high temperatures in spring (especially with reflecting snow) and summer, especially the noon temperature and the

maximum temperature. In table 4.2 the monthly mean differences are presented. They are calculated with the Ekholm-Modén formula, Appendix II, formula (28) using three clock-readings and the two extreme temperatures. We see that the maximum difference in early summer is 0.4°C with higher values in the shelter than in the Stevenson screen. For minimum temperatures no significant differences were found (Modén, 1954).

Table 4.2 Monthly mean differences (in 0.01°C) between Swedish free-standing screen and shelter.

Jan	Feb	Mar	Apr	May	Jun	Jul	Aug	Sep	Oct	Nov	Dec	Year
0	-10	-20	-20	-30	-40	-40	-30	-20	0	0	0	-20

In United Kingdom the so called Gaisher stand were in widely use until 1873 when the Stevenson screen was recommended by the Royal Meteorological Society (Parker, 1992). The Gaisher stand was also a free-standing shelter for which different comparisons with Stevenson screens are known. Parker has quoted four of them from different places, op.cit. A similar overheating in spring and summer as for the Swedish screen was also found for the Gaisher stand.

5 Comparisons of free-standing screens and wall screens

Before the new free-standing screens replaced the wall screens, comparison measurements were often performed at the observatories. Also double measurements at the stations have been done. This is important because a change from a wall screen to a free-standing screen also involves a relocation from a wall of a house to a place which should not be influenced by any obstacles. Test results therefore not only depend upon the different screens, but also on the orientation, colour, winter heating, size of the house etc. Denmark and Iceland took the precaution of double measurement at a number of stations, while Norway in the early 1930s replaced the wall screens without comparison measurement.

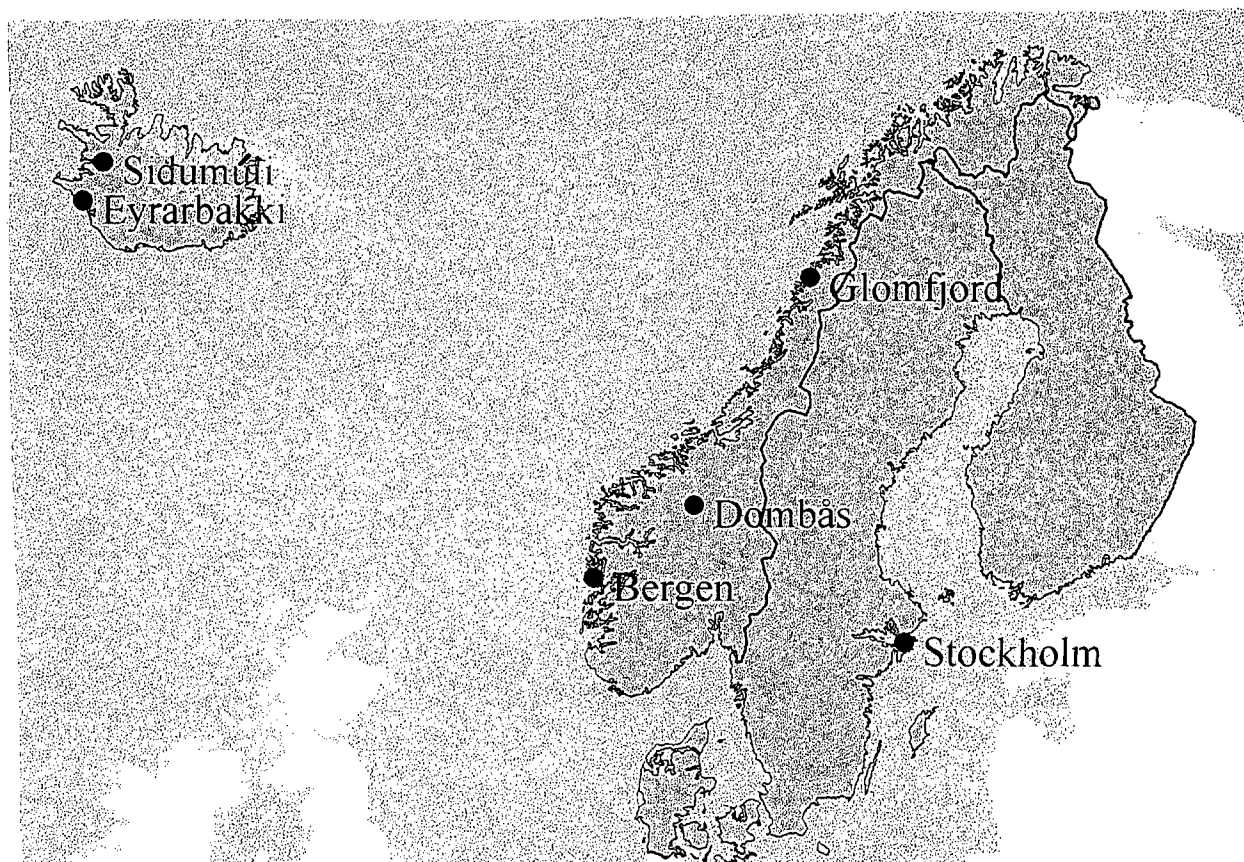

Fig. 5.1 Meteorological stations where parallel temperature measurement within wall screens and free-standing screens have been carried out. Danish stations are shown in Fig. 5.2.

None of the test results in this chapter have earlier been published in English. Some of them are available in national languages or in German, while others are unpublished. Earlier published results will be given a brief summary only. Whatever used in the original papers, all differences between the screens in this chapter will be calculated as follows:

$T_{\text{free-standing screen}} - T_{\text{wall screen}}$, thus negative differences mean that the wall screen is warmer than the Stevenson screen.

5.1 Results from 6 Danish comparisons

In the period 1971 to 1989 parallel, temperature measurements were carried out at wall screens and free-standing screens of the standard Danish Stevenson type. The series consisted of daily data, measured at 8, 14 and 21 UTC. The distance between the wall screens and the Stevenson screens varied between 10 to 50 meters. Fig. 5.2 and table 5.3 show the geographical positions of the stations.

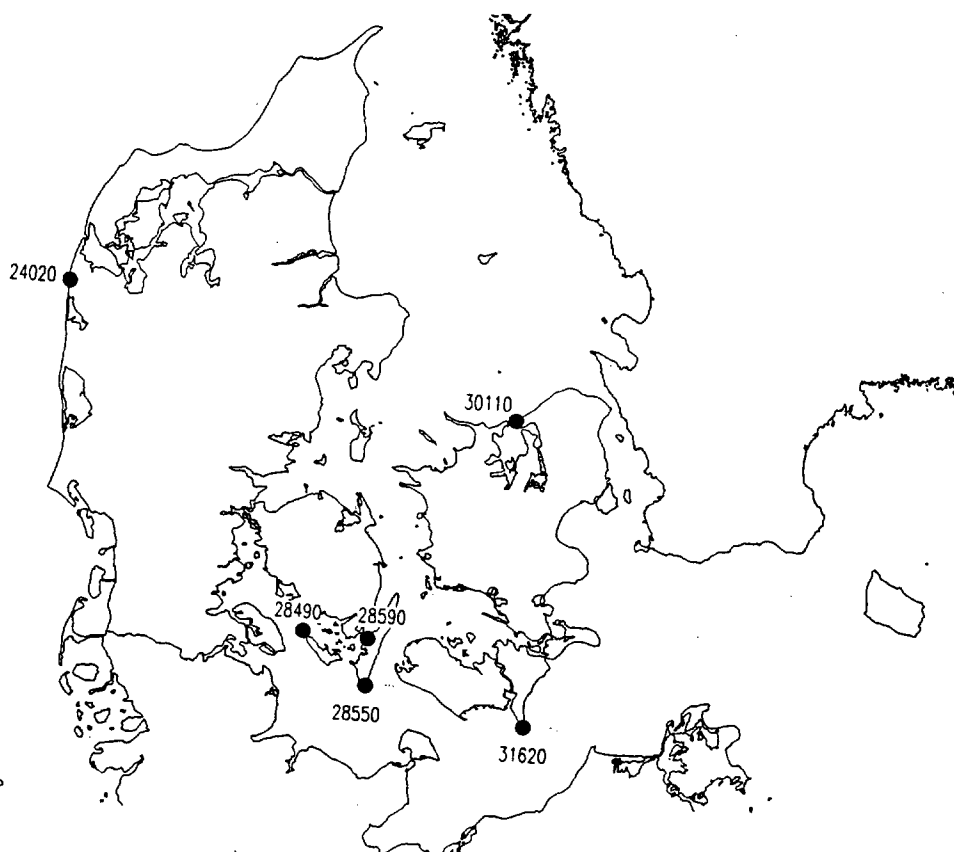

Fig. 5.2 Stations used for parallel temperature measurement within wall screens and Stevenson screens in the period 1971 to 1986. The stations are: 24020 Bovbjerg Fyr, 28490 Skjoldnifs Fyr, 28550 Keldsnor, 28590 Rudkøbing, 30110 Spodsbjerg Fyr, 31620 Gedser Fyr.

In Fig. 5.3 the temperature differences between the free-standing screens and the wall screens are shown. Five of the stations show almost similar variations of the difference throughout the year, i.e. their amplitude being within a 0.3 °C interval. The wall screen tends to get warmer in summer compared to the Stevenson screen. At one station, 24020 Bovbjerg, the differences are remarkably different from the others. Here the wall screen is 0.3-0.4 °C warmer in the winter and up to 1.1 °C warmer in the summer.

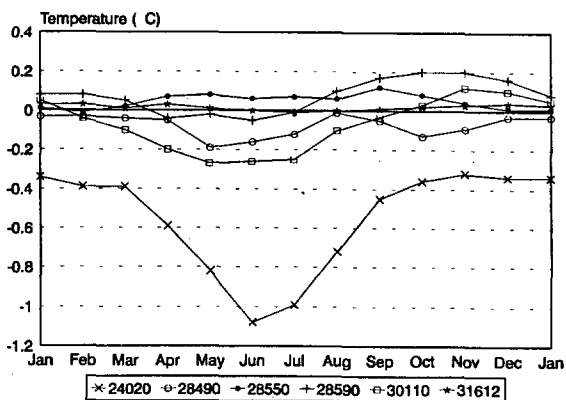

Fig. 5.3. The temperature difference between wall screen and Stevenson screen at 6 Danish stations.

In order to explain the deviation of station 24020 Bovbjerg from the others, the station history has been carefully studied. Photos and maps of the station show that the cage was placed on a wall in a yard surrounded by buildings. Only a narrow east facing sector was open while the Stevenson screen was placed at an open area, Fig. 5.4.

The way the wall screen is sheltered by houses indicates that the wind speed and/or the direction could have great influence on the temperature difference. In table 5.1 the notations 'Low' and 'High' are used for wind speeds ≤ 4 m/s and > 10 m/s respectively while wind direction notation 'East' comprises the easterlies (NE, E, SE) and 'West' the westerlies (SW, W, NW). The results showed in fact that both wind speed and wind direction had a significant influence on the temperature difference. In case of low wind speeds, the wall screen was relatively warmer than the Stevenson screen. It is therefore suggested that the long building next to the lighthouse acted as a local heating source which had its greatest effect when the wind speeds were low. The wall screen got cool relative to the Stevenson screen when the wind came from east and blew through the opening.

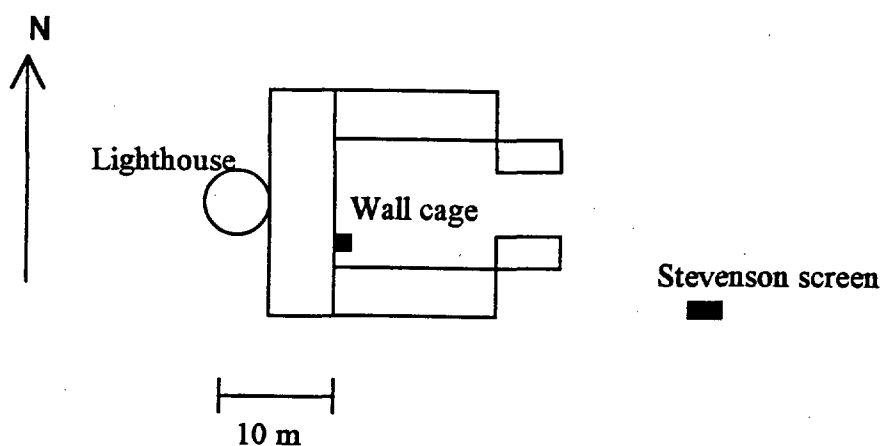

Fig. 5.4 At station 24020 Bovbjerg the positions of the wall screen and the Stevenson screen are shown relative to the lighthouse buildings.

Table 5.1 The influence of wind speed on the difference between temperatures ($^{\circ}\text{C}$) measured in wall screen and Stevenson screen. **: Significance Level $< 1\%$, *: $1\% < \text{Significance Level} < 5\%$.

Station	Wind speed			Wind direction		
	Low	High	SL	East	West	SL
24020	-0.66	-0.43	**	-0.39	-0.66	**

In order to investigate the effect of the weather on the difference between Stevenson screen and wall screen the observations were grouped according to four weather elements. The following notations are used in table 5.2: Snow cover is defined as existing when more than 50% of the ground was covered with snow, not existing when 50% or less was covered. The category fair means that less than 20% of the sky was covered with clouds while cloudy means more than 80% coverage, and only cases with no rain were included, so the 'rain' factor has no influence on the 'cloudiness' factor. A 'Low' temperature is defined as a temperature among the 20% lowest and a 'High' temperature is among the 20% highest temperatures. 'Rain' is defined as $\geq 1\text{mm}$ of precipitation during the last 24 hours.

The four weather elements in table 5.2 and the wind speed are expected to be those mainly influencing the difference between the measured temperature in the wall screen and the Stevenson screen. The differences between screens generally tend to vanish at high wind speeds. This may, however, not be true in these cases because the wall screen may be sheltered by the lee effect of the house while the Stevenson screen is ventilated through the louvered walls. The effect of wind is therefore highly influenced by variable environmental conditions and are not investigated here.

Table 5.2. The influence of some weather elements on the difference between temperatures (°C) measured in wall screen and Stevenson screen.

** : Significance Level (SL) < 1%, * : 1% < Significance Level (SL) < 5%.

Station	Snow cover			Cloudiness (no rain)			Temperature			Rain		
	No	Yes	SL	Fair	Cloudy	SL	Low	High	SL	No	Yes	SL
24020	-0.31	-0.47	**	-0.60	-0.62		-0.41	-0.80	**	-0.65	-0.49	**
28490	-0.05	0.02	**	0.11	-0.16	**	-0.04	-0.05		-0.06	-0.10	**
28550	-0.03	0.05	**	0.25	0.00	**	0.03	0.14	**	0.09	0.01	**
28590	0.11	0.12		0.15	0.02	**	0.09	0.05	*	0.08	0.08	
30110	0.08	-0.03	**	0.11	-0.13	**	-0.04	-0.13	**	-0.10	-0.07	*
31620	0.02	0.07	**	-0.04	0.02	**	0.04	-0.01	**	0.01	0.03	**

From table 5.2 we see that it is hard to get a clear picture of the effects of the different elements even though most of the differences are significant. The snow cover can change the temperature difference in both negative (24020 Bovbjerg) and positive (28490 Skjoldnæs) direction. Cloudiness seems to change the difference in a negative direction except in one case (31620 Gedser) and temperature also changes the difference in negative direction except for one station (28550 Keldsnor). Rain works in both positive and negative directions.

According to this test, the following conclusions can be drawn:

- The difference does not have a general value, not even on a monthly basis, although there is a tendency towards the wall screen getting relatively warmer than the Stevenson screen in the summer.
- Most average differences are less than 0.2 °C.
- Environmental conditions such as local heating sources, shading effects and surface underneath the wall screen or Stevenson screen might have a greater effect than the screen itself.
- Snow cover and rain show significant but unsystematic influence on the temperature difference while clear weather and high temperature tend to make the wall screen a little warmer than the Stevenson screen.

5.2 Test results from Síðumúli and Eyrarbakki in Iceland.

Síðumúli (64°43'N, 21°22'W). The site is a farm located 78 m a.s.l., in a broad valley area in Western Iceland, Fig. 5.1, on the southern side of a low mountain ridge. The wall screen was replaced on July 8, 1958 and comparison measurements were made for exactly one year, only a very few comparisons are missing during this period. Observations were made at 9, 12, 15, 18 and 21 UTC. The results are very typical for the bulk of the comparison measurements of the 1950s and early 1960s, namely they indicate a summer-afternoon difference maximum where the new screen is slightly colder than the old one, Fig. 5.5a) and Appendix I, table 1.

During the period April - August the new screen is colder at all of the five observing times, but in winter slightly warmer during the evening. The winter differences were irregular and did not seem to respond in any significant way to cloud cover or precipitation (not shown). The summer measurements on the other hand reveal a marked cloud related influence. At fair skies the new screen is on the average 1.0°C colder than the old one at 18 UTC, but only 0.3°C colder when it is overcast, Fig. 5.5b. If the overcast cases are split in two groups, with and without concurrent (or recent) precipitation the difference is larger in the dry group than in the «wet» one, Appendix I, table 2. There is also a marked difference if one separates the overcast group into two subgroups according to the low cloud cover in the synoptic message. The difference between the two screens is larger if the low clouds are broken.

Eyrarbakki (63°52'N, 21°09'W). The site is located in a small fishing community at the southern coast, Fig. 5.1. There is a low ridge (of a few meters height) between the sea and the village. Otherwise the land is very flat. The wall screen was replaced on August 11, 1961 and comparison measurements were made for more than a year, to the end of December 1962. Observations were made at 9, 12, 15, 18, 21, 24 UTC. The results for this station must be considered atypical in the sense that this is the only station showing consistently warmer temperatures in the new screen compared to the old one during the summer, Fig. 5.5a and Appendix I, table 3. The difference is largest around noon. This behaviour is most likely due to the location of the old wall screen at a spot with a delayed warming in the morning. The differences in the winter are irregular and slight.

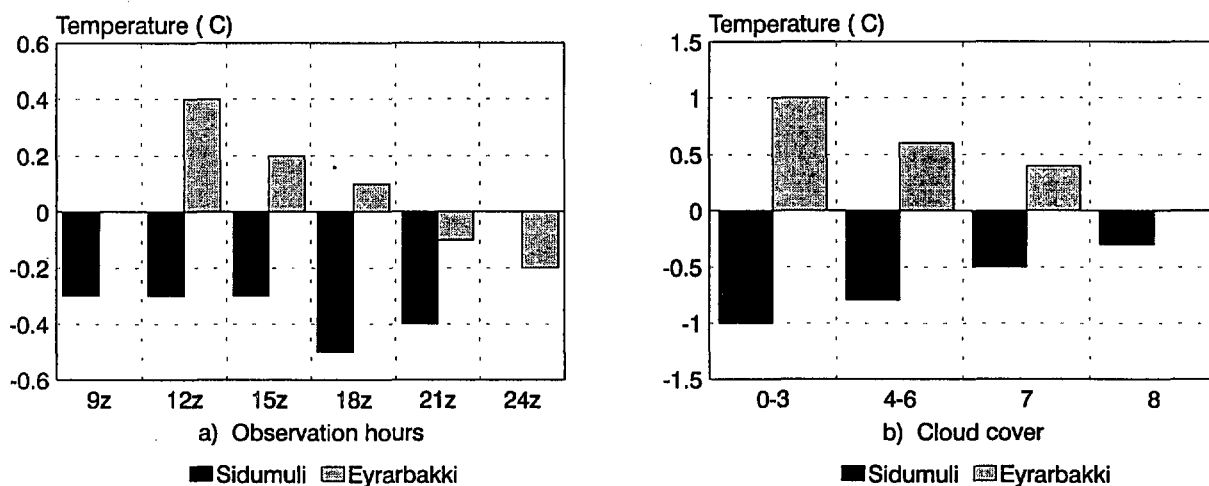

Fig. 5.5 Temperature difference between free-standing screens and wall screens at Eyrarbakki (grey) and Síðumúli (black) in Iceland during the season April-August. a) Observation hours. b) Cloud cover dependence of the difference. Eyrarbakki at 12 UTC, Síðumúli at 18 UTC.

The difference in April - August is very cloud cover dependent, i.e. 1.0°C in fair weather but if the weather is overcast there is no difference between the two screens. There is not any significant difference between "dry" and "wet" conditions. This contrasts with the results from Síðumúli. The contrast between overcast and broken low cloud cover in overcast conditions is only slight, Appendix I, tables 2 and 4.

5.3 Test results from Dombås, Norway

Near the former weather station Dombås a test field (62°04'N, 9°08'E, 653 m a.s.l) for temperature was in operation from November 1988 to March 1995 with 100 % data recovery. A yellow painted metal wall screen without floor (the one introduced 1875, Fig. 2.5) was tested against the standard screens MI-33 and MI-46. Inside the screens were sensors of Aanderaa type calibrated at DNMI and also through numerous manual readings of mercury control thermometers. In the wall cage without a floor there might not have been black box radiation conditions and therefore as a precaution the sensor inside it was equipped with a glass tube which covered the sensor completely. The narrow space between the sensor and the inner glass surface was filled with mercury to simulate a traditional thermometer, with respect to radiation conditions as well as to inertia. Some results from the test field are given in Fig. 5.6 and 5.7 and table 5.3.

Fig. 5.6 shows that the temperature difference has an annual cycle. The largest values (MI-46 warmest) occurred during late autumn and winter and negative values (wall screen warmest) at late spring and early summer. The lowest mean monthly difference occurred in June when the global radiation reached its maximum value and the highest value occurred in the coldest month, January. It was also found that during winter, night differences were correlated ($r = -0.5$, highly significant) with the cloud cover at the station Kjøremsgrendi about 5 km away.

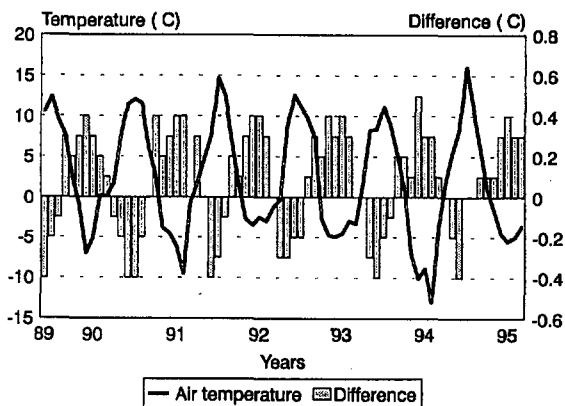

Fig. 5.6 Annual cycles of monthly mean temperature inside screen MI-46 and the temp. difference between this screen and a wall screen, period 1989.06 - 1995.03.

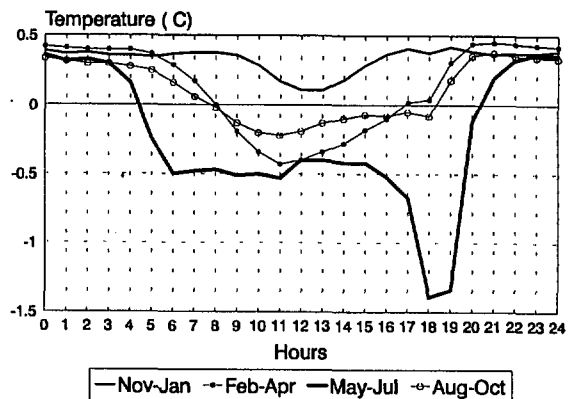

Fig. 5.7 Diurnal variation of mean seasonal temperature differences between screen MI-46 and a wall screen through the period 1989.05 - 1995.02.

The diurnal cycle of the difference between MI-46 and the wall screen is shown in Fig. 5.7 for four seasons of the year. In the season Nov-Jan the free-standing screen was on the average warmest during the whole day, but this difference was somewhat reduced at midday. The seasons Feb-Apr and Aug-Oct had approximately the same values during most of the day. At

midday the wall screen was warmer relative to the free-standing screen; more pronounced in Feb-Apr than in Aug-Oct. The reason was probably the snow, which covered the ground in the first season but was absent in the second one. Reflection of short wave radiation from the snow cover is an additional contribution to the radiation reaching the screens. This might have led to more overheating in the yellow painted single louvered wall screen than in the white double louvered free-standing screen.

Even in May-Jul the MI-46 was warmer at night, about 0.4°C during several hours. At day time the wall screen was about 0.5°C warmer than the free-standing screen in the hours from 6^{h} to 16^{h} , independent of solar height. During the following hours an abrupt change took place, the wall screen was warmed up relatively to the free-standing screen as the sun's azimuth made it possible for the sun to shine at the wall.

The positive differences (free standing screen warmest) occurred mainly when the sun was under the horizon or when the solar angle was low like in Nov-Jan. At such occasions inversions at the test field are built up (Nordli, 1995b). Inversions may cause the wall screen to be colder than the free-standing screen by:

1. The open floor exchange radiation with the colder (snow covered) ground making the sensor colder than the ambient air.
2. Dombås test field is situated at a valley side near the top of a hill and a shallow drainage flow is establish. The house causes the air to stagnate and consequently the air at the upslope northern side of the house (where the wall screen is located) may be colder than the air near by the house (where the free-standing screen is located).

In order to evaluate these effects, two additional sensors with exactly the same Aanderaa type of screen, Fig. 2.12, were placed at the test field during the winters 1993/94 and 1994/95, one near the wall screen and the other near the free-standing screen. The sensors were properly calibrated before and after the test by DNMI, and as an extra precaution they replaced each others after the first test winter.

In the season November-March the average temperatures during nights (19^{h} - 07^{h}) were calculated for the two winters the Aanderaa screens were in operation. During 294 nights the average difference between the MI-46 and the wall screen was -0.37°C compared with the difference between the Aanderaa screens of -0.30°C . The standard deviation for both of the series of differences were 0.3°C . Hence most of the difference between the ordinary screens is also maintained between the additional Aanderaa screens. Those screens have floors which exclude effect no. 1. Therefore this effect must be small compared to effect no. 2.

The results from Dombås should be compared to those at Glomfjord, see Ch. 5.4, which is also located at a similar site in a south facing slope, somewhat steeper than the one at Dombås. Also at Glomfjord the monthly mean temperature at the wall screen is colder than at the free-standing screen in winter, and the values even exceed those from Dombås. Effect no. 2, stagnating air above the house, may explain also the great differences at Glomfjord.

In summer the wall screen was warmer than the free-standing screen at Dombås (table 5.3, test 10) and in June at Glomfjord (test 9), but at the Bergen Observatory (test 8) the opposite was true. At the observatory the free-standing screen was of the Norwegian Screen type which is

overheated in summer (table 3.1, test 3) compared with the screen of pattern 1946. Taking the overheating into account, the test results for these Norwegian wall screens during summer do not differ much from each other.

5.4 Short survey of earlier published Nordic test results

Bergen (60°24'N, 5°19'E), Norway. The meteorological Observatory in Bergen, Fig. 5.1, was situated at the fortress Fredriksberg where double measurements were performed for a free-standing «Norwegian Screen» and a box formed metal screen, Fig. 2.5, of the type set in operation in 1875. The test took place during the years 1907-1914 at the three standard hours of observation (Føyn, 1915). In table 5.3 differences of mean monthly temperature obtained by the test are given. There are practically no differences between the screens in the season April - August, but in wintertime the free-standing screen is 0.2 - 0.4°C warmer than the wall screen.

Stockholm (59°20'N, 18°03'E), Sweden. For the period October 1960 to December 1961 the window screen, Fig. 2.4a, at Stockholm Observatory was compared with a Stevenson screen (Modén, 1963). It should be mentioned that the window screen was partly sunlit when the morning reading was made. This is the main reason for the mainly negative values (warmer window screen) in table 5.3. The midday observations were instead on the average 0.3°C warmer in the Stevenson screen. It is assumed that the differences in June to August could have been a bit larger if the summer had been more normal. The 1961 summer was very cloudy and wet with few sunshine hours. The sunlit morning observations do not affect the Stockholm series before 1947 when the reading was made one hour later.

Glomfjord (66°49'N, 13°59'E), Norway. As far as we know there are two exceptions from our main statement that the wall screens were replaced by free-standing screens in 1930s. At Glomfjord, Fig. 5.1, the change did not take place before 1957 and double measurements were performed during the whole year of 1956 (Bruun, 1957). The reference screen was MI-46. The results gave rather astonishing results: During the whole winter, from November to March the wall screen was 0.5°C or more colder than the free-standing screen.

Icelandic comparisons The old wall screens in Iceland were gradually replaced by a new type of a free-standing screen during the period 1948 - 1964. Comparison measurements were conducted at a number of stations for periods of 2 - 27 months. In most cases these were restricted to readings of the dry-bulb thermometer. At only one station comparison readings of maximum and minimum temperature were also conducted.

The comparison measurements yielded somewhat variable results from station to station, but in most cases there were a consistent seasonal and diurnal variation of the differences. The differences clearly related to radiation exposure, being largest in daytime during summer. The average screen differences at 8 stations at 9 and 21 UTC are given in table 5.3 (VI, 1962). These differences are similar to the official differences in monthly mean temperature if the averaging formula is based upon the same observational hours.

5.5 Summary and discussion

The results of the comparisons in table 5.3 differ a lot. Nevertheless some features seem to be common for most of the screens at the various test locations.

Table 5.3 Monthly mean differences (in 0.01°C) between free-standing screens and wall screens.

Country	Free stand. screen	Test	Jan	Feb	Mar	Apr	May	Jun	Jul	Aug	Sep	Oct	Nov	Dec	Yr
Denmark	St. scr.	1	-34	-51	-39	-59	-82	-108	-99	-72	-45	-36	-32	-34	-58
	St. scr.	2	-3	-3	-4	-5	-19	-16	-12	-1	-5	-13	-9	-3	-8
	St. scr.	3	1	-1	2	7	8	6	7	6	12	8	4	1	5
	St. scr.	4	8	8	5	-4	-2	-5	-1	10	17	20	20	16	8
	St. scr.	5	5	-33	-10	-20	-27	-26	-12	-10	2	3	12	10	-9
	St. scr.	6	3	3	1	3	1	0	-1	0	1	2	3	4	2
Iceland	VI	7	10	20	10	-10	-10	-30	-30	-20	0	10	10	10	-3
Norway	Norw.	8	28	21	20	9	5	7	1	5	18	32	30	37	18
	MI-46	9	60	50	50	20	10	-10	20	20	30	40	50	50	33
	MI-46	10	36	30	10	5	-18	-25	-12	-6	11	13	9	28	7
Sweden	SMHI	11	-10	-10	0	0	-10	-20	-20	0	10	0	-10	-10	-7

Tests:

1. Bovbjerg Fyr (24020), (56°31'N, 08°07'E), Western Jutland. Period 1971 - 1987. Not earlier published.
2. Skjoldnæs Fyr (28490), (54°58'E, 10°12'E), Ærø Island. Period 1971 - 1983. Not earlier published
3. Keldsnor (28550), (54°44'N, 10°43'E), Langeland Island. Period 1971 - 1987. Not earlier published
4. Rudkøbing (28590), (54°57'N, 10°43'E), Langeland Island. Period 1971 - 1987. Not earlier published
5. Spodsbjerg Fyr (30110), (55°59'N, 11°51'E), Sjælland. Period 1971 - 1974. Not earlier published
6. Gedser Fyr (31612), (54°34'N, 11°58'E), Falster Island. Period 1971 - 1982. Not earlier published
7. Mean values from 8 Icelandic stations in the period 1948 - 1962. (VI, 1962).
8. Fredriksberg observatory (50560), Bergen, Western Norway. Period: 1907.01 - 1914.12. (Føyn, 1915).
9. Glomfjord (80700), Northern Norway. Period: 1956.01 - 1956.12. (Bruun, 1957).
10. Dombås (16550) central mountain area, Southern Norway. Period: 1989.06 - 1995.03, Not earlier published.
11. Stockholm Observatory, Eastern Sweden. Period: 1960.10 - 1961.12 (Modén, 1963).

During summer the wall screens are warmer than the modern free-standing screens. Thus the mean values of 8 Icelandic and 5 Danish comparisons as well as results from test fields at Dombås and Norrköping reveals differences of 0,1-0.3°C. The extraordinary behaviour of some of the screens may be explained: At Bovbjerg the wall screen was surrounded by buildings at almost all sectors while the free-standing screen was located outside the building complex. A local heat source, e.g. exhaust pipe from a generator cannot be excluded. At Eyrarbakki the site of the old wall screen was placed at a spot with delayed warming in the morning. At Fredriksberg the differences will fit into the usual pattern if they are adjusted for the old type free-standing screen used in the comparisons.

Mean differences from two Icelandic stations (Síðumúli and Eyrarbakki) have opposite sign. Grouping of the observations into classes of cloud cover reveals enhanced differences in fair weather. The one of the screens which is most affected by short wave radiation, will be more overheated than the other one.

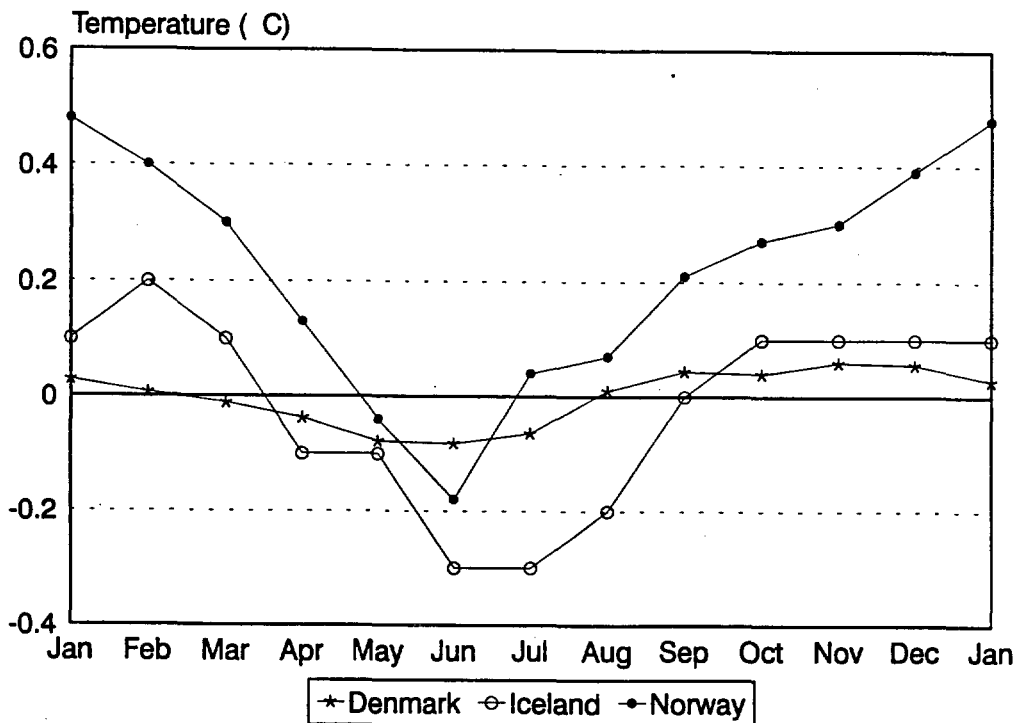

Fig. 5.8 Mean monthly temperature differences: Free-standing screens minus wall screens from Denmark (tests 2-6), from Iceland (tests 7), and from Norway (tests 9-10).

In winter the bulk of comparisons do not reveal differences greater than 0.1°C . This value is of the same magnitude as the error of station thermometers. Two series of double measurements from Norway contrast with these results and show differences from 0.3°C to 0.6°C during winter months. On the basis of special measurement at Dombås test field the reason for these great differences are suggested to be stagnation of cold air at the upper side of the houses where the wall screens are located.

Like Dombås the farm Síðumúli is situated in a valley, but unlike Dombås the winter differences are near zero. This discrepancy is suggested to be caused by different local climates. Síðumúli encounters a strong and thus turbulent drainage flow whereas the air at Dombås in fair weather situations is typically calm. Then air near obstacles may easily stagnate and loose heat by long wave radiation. Before transferring comparison results from one site to another, it is essential to take into account different local climates.

6 Comparisons of free-standing screens and sensor screens.

On a fairly unobstructed grass surface close to SMHI in Norrköping parallel measurements were performed through the period April 1989 - February 1990 (Andersson & Mattisson, 1991). Their main issue was to evaluate the new type of screens used to protect platinum resistor thermometers at automatic stations. Some of the screens represented in the tests are listed in table 6.1. A Teledyne screen with a high quality sensor was used as reference and also the SMHI Stevenson screens.

Table 6.1 Sensor screens tested by Andersson and Mattisson (1991).

Lambrecht	Screen on (ordinary) short pole, catalogue no 814, aluminium, eloxal processed, diameter 17 cm, height 44 cm.
Vaisala	Type DTR11, fibre glass reinforced polyester, diameter 22 cm, height 29 cm
Young	Model 4104, white thermoplastic, diameter 12 cm, height 27cm

The differences between the Teledyne ventilated thermometer and the three sensors are shown in Fig 6.1a for June and in 6.1b for December. For comparison the ordinary SMHI free-standing screen is also represented in the figure.

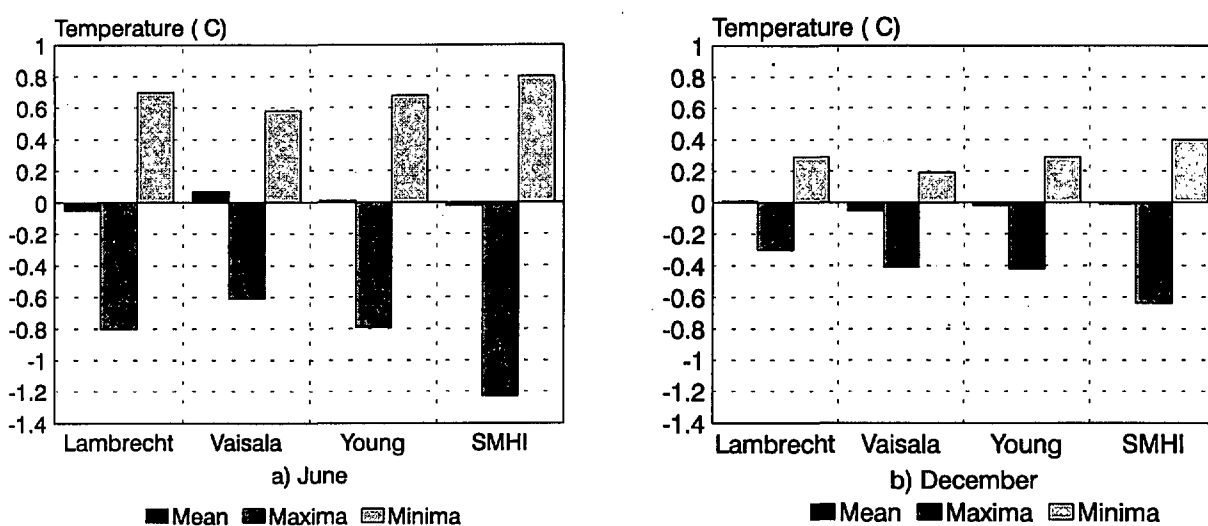

Fig. 6.1 Differences between sensors, ventilated minus screened, Norrköping, a) June 1989 and b) December 1989. The maxima (minima) denotes the monthly means of the largest (smallest) daily difference. From table 3 in Andersson & Mattisson (1991).

The mean of the daily extreme differences were large, especially for the ordinary free-standing screen, Fig. 6.1. The differences were larger in June when the screens were exposed to irradiation than in December when the irradiation was zero-most of the day. In extreme cases individual differences amounted to about 3°C. Vaisala and Young sensor screens agreed best with the reference. The authors concluded that the large absolute differences were mostly caused by the varying response time, and that those differences cancelled each other. The positive and negative differences caused by radiation also tended to cancel each other.

In spite of the large individual differences the magnitude of the monthly mean differences was negligible, i.e. of the same magnitude as the measurement accuracy, which was estimated to be about $\pm 0.04^{\circ}\text{C}$. The root mean square for individual differences were about 0.2°C .

The ventilation due to wind minimised the screen effect. With wind speed higher than about 1m/s (somewhat depending upon the screen type and irradiation), the differences were close to zero. Under cloudy weather they were also close to zero.

At the Norwegian Meteorological Institute in Oslo parallel measurements were performed in the period from 14.10.1982 to 15.12.1983. Those measurements involved only two screens, the institute's novel sensor screen, type MI-74, and the ordinary free-standing screen, type MI-46, Fig. 2.14a and 2.10b respectively. Temperature was logged simultaneously in both screens at an interval of 10 minutes. Some printed test results are available in Norwegian language (Gislefoss, 1984).

The mean monthly differences between the ordinary screen and the sensor screen are shown in Fig. 6.2, positive values mean that the ordinary screen is warmer than the sensor screen. The diagram show mean difference of all observations as well as the mean difference of the daily maxima and minima for the entire observational period.

During the whole year the mean daily maxima is highest in the sensor screen, especially during summer. Thus in July and August the difference is almost 1°C . The mean daily minima are on the contrary highest in the ordinary screen. During the whole year the maxima are biased -0.45°C and the minima 0.30°C . The mean values of all observations, however, are not biased more than 0.03°C which is lesser than the accuracy of the sensors. The monthly mean differences range from -0.04°C to 0.11°C . According to Gislefoss (1984) the highest value is of the same order of magnitude as the measuring accuracy.

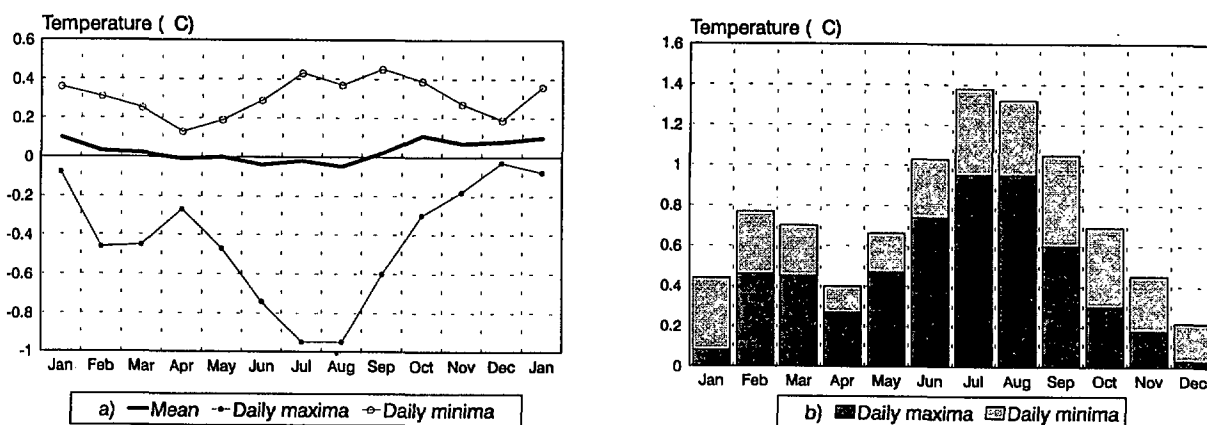

Fig. 6.2 Differences between sensors, ordinary free-standing screen minus sensor screen, Oslo, 14.10.1982 - 15.12.1983. Daily maxima (minima) denotes the monthly mean difference of the daily maximum (minimum) temperatures. At diagram b) the differences are stacked showing the differences of mean diurnal range.

The biases in both maximum and minimum temperature differences result in a bias in the diurnal range, Fig. 6.2b. The lesser inertia of the sensor screens is one important reason for its enhanced diurnal range. It is greatest in summer months when the main contribution comes from the differences in maximum temperature. This has led the author of the paper (op.cit.) to suggest that the sensor screen might be overheated relative to the ordinary screen when

exposed to solar radiation in calm weather. However, this did not affect the difference of monthly mean temperature beyond the limit of measuring accuracy.

The MI-74 screen can not be directly compared to those used in Norrköping because of the lack of a common reference. However, measurements quoted in chapter 3 in this report show that mean monthly temperature from the ordinary SMHI screen as well as the MI-46 are not biased compared to ventilated thermometers. The tests indicate that they are not biased compared to the sensor screens either. Therefore ordinary free-standing screens may probably be replaced by sensor screens without causing inhomogeneity in the series of monthly mean values. However, as the material is rather limited the possibility of biases in months with special weather condition can not be excluded, e.g. overrepresentation of calm weather in early spring when the ground is covered with snow.

Sensor screens are biased compared to ordinary screens concerning diurnal temperature range, for MI-74 this amounted to more than 1°C in the summer months from June to September. The largest contribution comes in summer from the maximum temperature, Fig. 6.2b. A replacements of the ordinary free-standing screen with sensor screen will therefore cause inhomogeneity in time series of maximum and minimum temperatures. The novel sensor screens should therefore be thoroughly tested as they now are commonly used in the national station networks. The diurnal range will not depend only on the inertia of the screens and sensors, but also upon the observational procedure defining the «now value», see chapter 2.3.

7 Results from statistical homogeneity testing procedures related to screen effects

A number of long Nordic temperature time series have been homogeneity tested using the "Standard Normal Homogeneity Test" (SNHT) (Alexandersson, 1986) which is chosen as the main testing procedure in the NACD-project. The principal idea of the test is to compare a test station with a group of homogenous reference stations. Test results of screen effects are available from stations shown at the map, Fig. 7.1

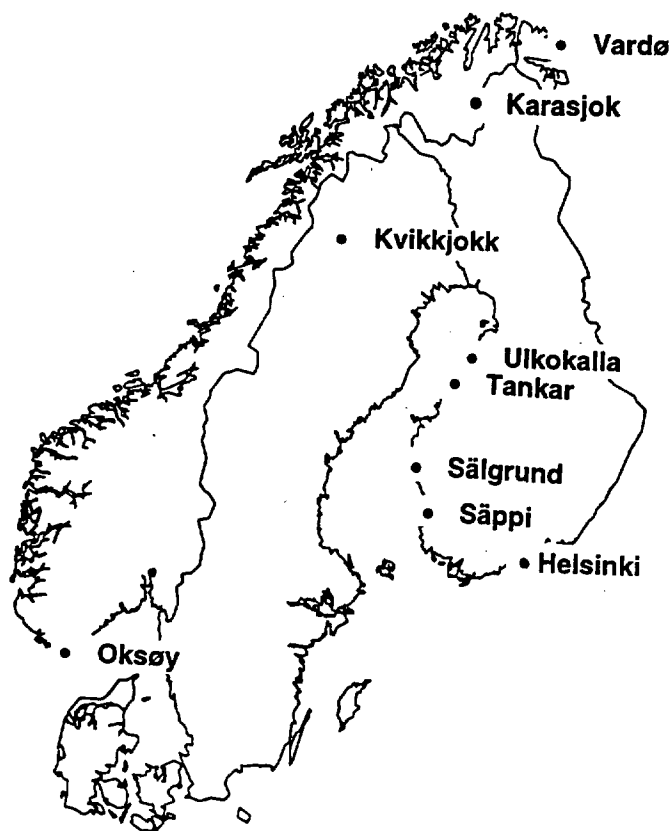

Fig. 7.1 Stations tested for screen changes by the Standard Normal Homogeneity Test (SNHT).

7.1 Change from wall screen (open shelter) to free-standing screen

At the meteorological station in Helsinki, Finland, window thermometers, Fig. 2.2c, were replaced by a free-standing screen of the Wild type already in August 1882. The SNHT detected the change and revealed positive monthly mean temperature adjustments throughout the year, i.e. the Wild screen was warmer than the window thermometers. The rather «noisy» adjustments, ranging from zero to 0.6°C, had maximum in summer.

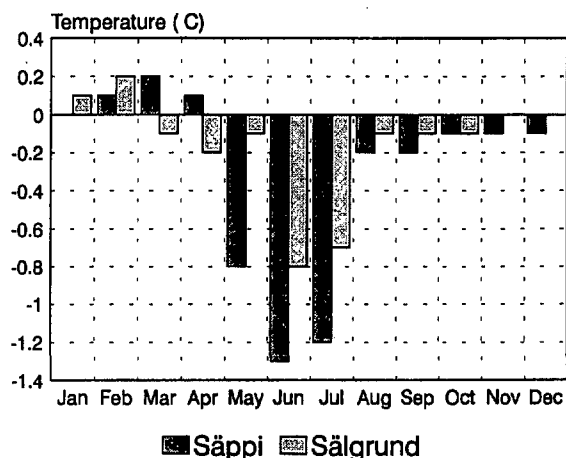

Fig. 7.2 Temperature difference between the Finnish «English» screen and wall screen at two lighthouse stations.

Tests have been carried out for more recent changes at Tankar and Ulkokalla in 1939 and Säppi and Sälgrund in 1930, all lighthouse stations, Fig. 7.1. Inhomogeneities were only discovered in the two last series. The adjustments are shown in Fig. 7.2. A study of the inspection reports reveal that the sun was able to shine on the cage at Sälgrund. This is a plausible explanation for the large adjustments in summer. The huge summer adjustments of Säppi are also very likely caused by sunshine on the cage. At Tankar, where no adjustments were found, inspection reports confirm that the cage was not under influence of direct sunlight. The description of the site of measurement at Ulkokalla is unfortunately superficial.

The lighthouse stations were not inspected as frequently as stations with good service. Therefore, the site of measurement was sometimes selected by the observer. The differences between free-standing screen and wall screen could be up to one degree during summer months, if the wall screens were badly installed.

In 1934 a screen change took place at the Norwegian lighthouse station Oksøy, Fig. 7.1, from wall screen to free-standing screen MI-30. Most of the surrounding stations had similar changes so only one station, Lindesnes, could be used as reference station in the test. The result of the SNHT was that no inhomogeneity near the actual year was detected.

At Kvikkjokk in Sweden, Fig. 7.1, the screen was changed at some time between the years 1921 and 1928. Test results gave significant adjustments in the summer months with a maximum value in June, -0.6°C . In the season September to March the adjustments were zero or negligible. The adjustments may be explained by a statement in the inspection report from July 1921, telling that the cage was exposed to direct sunlight during the summer months. A study of the time series of the test statistic reveals a rather «flat» maximum value in the 1920s. This indicates that the screen change was not the only reason for the inhomogeneity. A known relocation in 1918 may have obscured the effect of the screen change.

In Norway the SNHT has also been used as an internal test for observations at fixed clock hours. A series comprising observations at one fixed hour is then tested against observations at other fixed hours as if they were reference stations. In this respect the test has been an effective tool for adjusting for sunshine at wall screens. Significant results are found in most cases as should be expected looking in Fig. 5.7. Solar radiation may increase the mean temperature at clock hours, at least up to 1.5°C . In the summer season some Norwegian temperature series have been adjusted for sunshine, e.g. Oksøy and Vardø. The greatest adjustment was -1.5°C for one clock hour which amounts to about -0.3°C in the monthly mean value.

7.2 Changes caused by different types of free-standing screens

At Karasjok, Fig. 7.1, Northern Norway, in the period from 1936 - 1950 the single louvered Edlund Screen, table 2.2 and Fig. 2.8b, was in operation. Significant shifts in the series near those years were found by the SNHT in the summer season. Station history gave no other possible reason for the inhomogeneity than screen replacement. The adjustment of -0.4°C was attributed to the change from single louvered to double louvered free-standing screen. The Edlund Screen was also used for a period at Vardø, Fig. 7.1, an island near the North-eastern tip of Norway. In this maritime and windy climate no significant effect of the screen change was found.

A screen change from MI-30 to MI-33 took place at the lighthouse station Oksøy, Norway, in 1951. The test statistic of the SNHT reached a highly significant maximum value that year. During summer months the adjustment was about -0.3°C . The screen change was, however, combined with a relocation of 75 m. In this windexposed, flat and treeless terrain it is unlikely that minor relocations should cause inhomogeneities in the series. Therefore the main reason for the inhomogeneity is very likely the screen change.

During the first two decades of this century several screen changes took place in the Finnish network in combination with relocations. All significant inhomogeneities detected by the SNHT could be traced back to this combined effect. However, some well documented screen changes have taken place without relocations, but the SNHT was not able to detect them. It seems that the inhomogeneities caused by screen changes were smaller than those caused by relocations. The station network in the first decades of this century in Finland was relatively sparse. As the effectiveness of the SNHT depends on the reference stations, it was no surprise that small discontinuities, like screen changes from Wild to Stevenson type, were not detected.

8 Summary and conclusions

The screens used in the Nordic countries from 1870 were mainly wall screens. These screens were replaced by free-standing screens over a rather long time span. In Sweden, the free-standing screen was introduced already about 1880 at lighthouse stations. However, they did not come into use at a great number in the Nordic countries until the present century. After the 1980s the wall screen has not been in operation at ordinary stations. In connection with automation, a new type of screen was constructed for electronic scanning sensors. The form was cylindrical with louvered walls, and much smaller dimensions than traditional screens. Their number has increased in the station networks, especially in the 1990s.

The free-standing screen has improved during this century. The main improvements have been double roof and floor and double louvered walls. Several screen types have been tested against ventilated thermometers at latitudes around 60°N. In the season from October to February, monthly mean values from all screen types followed the mean values of the ventilated thermometers, the differences being less than 0.1°C. During the rest of the year the single louvered screens were overheated relative to the ventilated thermometers, by 0.2 - 0.4°C in the season May - August. Inside the double louvered types, overheating might occur in calm weather or at low solar angles. For monthly averages, however, the surplus of heat increased the temperature only 0.1°C or less. This is of the same magnitude as thermometer errors. Concerning individual observations, the screened thermometers might not follow the ventilated thermometers very well, mainly because of different inertia involved in the measurements.

Parallel measurements were performed at several stations when wall screens were replaced by free-standing screens. The bulk of the measurements revealed somewhat higher temperature in the wall screen than in the free-standing screen at midsummer. Thus the mean differences from 8 Icelandic comparisons were 0.3°C in June and July and at the Norrköping and Dombås test fields the wall screens were about 0.2°C warmer in June. Also three of six Danish tests showed significantly higher temperature in the wall screens than in the free-standing screens, while the rest of them reveals differences less than $\pm 0.1^\circ\text{C}$ during summer. Some of the Danish comparisons were however performed at locations, which are known to reduce the bias, i.e. windy coastal sites and/or stations located in the shadow of large trees. The real biases for the whole network could thus be significantly larger, when taking into account the number of inland stations and stations more exposed to direct sunshine.

During winter, differences are less than 0.1°C for most of the tests. Two Norwegian comparisons, however, differ substantially from the other ones. At Glomfjord and at the Dombås test field, the wall screens were colder during winter, with mean differences in January 0.6°C and 0.4°C colder, respectively. Both stations were situated at slopes, and during inversions the houses are suggested to cause the air to stagnate near the upper side walls where the screens were located. The combined effect of stagnated air and long wave radiation led to enhanced stratification. Consequently the air at the upper walls was colder than the air at the free-standing screens.

A change from wall screen to free-standing screen involves also a relocation and may therefore lead to different results at different sites. The results may depend on the orientation

of the house, colour, winter heating, size, height above the ground of the thermometers, latitude, local topography, horizon etc. And as demonstrated by the Dombås data, a house is an obstacle which may generate a special micro-climate during inversion situations. When transferring comparison results from one site to another, differences in local climate must be taken into account. However, the factors involved are many and each of them may be difficult to assess. We can thus not recommend general adjustment factors for change of screen type in e.g. national networks.

Some novel sensor screens were tested against ventilated thermometers or double louvered free-standing screens. On monthly basis the differences obtained were practically never outside an interval of $\pm 0.1^\circ\text{C}$, i.e. about the same magnitude as the measuring accuracy. The instantaneous values may, however, differ considerably. The main reason is the different inertia of the screens compared to ventilated thermometers. Especially the ordinary free-standing screens react slowly to abrupt temperature changes, considerably slower than the small sensors and screens at automatic stations. Consequently the maximum temperature will be higher and the minimum temperature lower in sensor screens than in free-standing screens. Combined, these changes cause a larger diurnal temperature range in sensor screens than in free-standing screens. A mean monthly difference of 1.4°C in July was found by a test in Oslo.

Generally the largest temperature differences between screens occur under strong irradiation in calm weather conditions. Reflection from snow covered ground enhances irradiation reaching the screen and therefore also tends to enlarge the differences.

Some significant inhomogeneities caused by screen changes were detected by the "Standard Normal Homogeneity Test" (SNHT). At some Finnish lighthouse stations large adjustments were found for temperatures measured in wall screen relative to free-standing screen. Sunshine at the wall screen was documented by the inspection report and was considered to have contributed to the large adjustment. Sunshine at wall screens also caused inhomogeneities of several Norwegian time series. The largest adjustment was -1.5°C applied on the average temperature at one clock hour, which contributes to about -0.3°C in the mean value. About the same overheating was also found by parallel measurements at a test field in Norway.

Many of the known screen changes were not discovered by the SNHT. Based upon experience with the test on seasonal data, inhomogeneities lesser than $0.1\text{-}0.2^\circ\text{C}$ are seldom significant at the 0.05 level, depending somewhat on the length of the series and correlation between the test station and the reference stations. As screen effects usually are smaller than this limit, they turn out to be insignificant. Often changes of screens take place in connection with relocations. In this case the inhomogeneities were likely to be detected by the SNHT but the effect of the screen change could not be separated from the effect of the relocation.

Long time series of mean temperature often have to be adjusted for inhomogeneities by adding an adjustment term to the oldest part of series, i.e. before the shift. About the adjustments of monthly mean temperature caused by screen changes, we may conclude:

- Mostly all screen changes do not cause inhomogeneities in winter.

The remaining conclusions are related to late spring and summer conditions only.

- Change from wall screen to single louvered screen most probably causes positive adjustments.
- Change from wall screen to double louvered screen most probably causes negative adjustments.
- Change from single louvered to double louvered screen causes adjustments at inland stations of about -0.2°C to -0.4°C .
- Change from double louvered to sensor screen probably causes no adjustment.

The most probable sign of the adjustments which should be applied to mean temperature is summarised in the table below.

Change of screen		Sign of the adjustment terms**			
From	To	Spring	Summer	Autumn	Winter
Wall screen	Single louvered*	+	+	0	0
Wall screen	Double louvered*	-	-	0	0
Single louvered*	Double louvered*	--	--	-	0
Double louvered*	Sensor screen	0	0	0	0

* Different types of free-standing screen, ** Adjustment term is to be added to the series before the change of screen.

++ (--) means positive (negative) adjustments found by an overwhelming majority of the tests.

+ (-) means a tendency of positive (negative) adjustments.

0 means that no adjustment is required or there is no clear tendency.

The improvements of free-standing screens have reduced the overheating and as a consequence led to inhomogeneities in some temperature time series. If this change in the network of stations has taken place during few years, it is impossible to find homogenous reference stations and consequently these inhomogeneities are not detected by the SNHT. Results from screen tests should in this case be taken into account and adjustments applied to the series before the homogeneity test procedure starts. However, overheating of the screens is more or less dependant on micro or local climate. Therefore the spatial representation of the screen tests should be taken into account when applying them on time series.

Acknowledgements

This study was partly founded by the Environmental Program of the European Commission (Contract: EV5V-CT93-0277).

Kjell Brandsberg and Sverre Skjåk, DNMI, are gratefully acknowledged for having scanned screen photos.

References

- Alexandersson, H. 1986. A homogeneity test applied to precipitation data. *Journal of climatology*, 6, 661-675.
- Andersson, T. 1970. Swedish temperature and precipitation records since the middle of the 19th century. National Swedish Council for Building Research, Univ. of Uppsala. 167 pp.
- Andersson, T & Mattisson, I. 1991. A field test of thermometer screens. SMHI, RMK No 62. Norrköping, Sweden, 40 pp.
- Birkeland, B.J. 1935. Mittel und Extreme der Lufttemperatur. *Geofysiske Publikasjoner*. Vol VII, 1-155.
- Buchan, A. 1868. *Handy Book of Meteorology*. Second edition, Edinburgh and London. 371 pp.
- Brandt, M.L., 1994: The North Atlantic Climatological Dataset (NACD), Summary of metadata from NACD-stations in Denmark, Greenland and the Faroe Islands 1872-1994. DMI Technical Report 94-20, 47 pp.
- Bruun, I. 1957. Lufttemperaturen i Norge I, 1861-1955. Norwegian Meteorological Institute. Oslo, 288 pp.
- Carter, T., M. Posch, H. Tuomenvirta. 1995. The development of climatic scenarios for assessing impacts of climate change. *Proc. from International Conference on Past, Present and Future Climate, Helsinki 22-25. August 1995*, p. 456-460.
- DMI. 1874. Danish Meteorological Institute. *Meteorological Yearbook*.
- DMI. 1876. Danish Meteorological Institute. *Meteorological Yearbook*.
- DMI. 1983. Danish Meteorological Institute. *Meteorological Yearbook, Part 1: Denmark and Faroe Islands*.
- DNMI. 1867. Norwegian Meteorological Institute. *Veiledning til Udførelse af meteorologiske Iagttagelser ved det norske meteorologiske Institutt's Stationer*. Christiania 1867, 14 pp. (Instructions for meteorological observations). Manuscript in Norwegian in the library of the institute.
- DNMI. 1871. Norwegian Meteorological Institute. *Veiledning til Udførelse af meteorologiske Iagttagelser ved det norske meteorologiske Institutt's Stationer*. Christiania, 1871, 29 pp. Manuscript in Norwegian in the library of the institute. (Guidance Notes on performing Meteorological observations at the stations of the Norwegian Meteorological Institute, 29 pp. English translation available from National meteorological Library, Bracknell, UK).
- DNMI. 1874. Norwegian Meteorological Institute. *Jahrbuch des Norwegischen Meteorologischen Instituts für 1874*. Vorwort, 7 pp. Christiania 1877.

DNMI. 1875. Norwegian Meteorological Institute. Jahrbuch des Norwegischen Meteorologischen Instituts für 1875. Vorwort, 5 pp. Christiania 1877.

DNMI. 1888. Udførelse af meteorologiske Iagttagelser ved det norske meteorologiske Instituts Stasjoner. Christiania 1888, 108 pp.

DNMI . 1937. Veiledning i meteorologiske iakttagelser 1937. DNMI, Oslo, 117 pp.

Easterling, D.R. & Peterson, T.C. 1992. Techniques for detecting and adjusting for artificial discontinuities in climatological time series: A review in: 5th International Meeting on Statistical Climatology. Toronto, 22-26 June 1992, Environment of Canada, p. 128-132.

Edlund, E. 1858. Handledning vid meteorologiska observationers anställande för de af K. Vetenskaps-Akademien för detta ändamål antagne observarörer. P.A. Norstedt & Söner, Stockholm.

Edlund, E & Hamberg, H.E. 1882. Handledning vid meteorologiska observationers anställande. Andra upplagen, Kongl. Boktrykkeriet, Stockholm.

Frich, P. 1993. Homogeneity problems in Danish and Greenlandic temperature time series. In: Contributions to Eighth symposium on Meteorological Observations and Instrumentation, Anaheim, California, January 17-22, 1993. 3 pp.

Frich, P., Alexandersson, H., Ashcroft, J., Dahlström, B., Demarée, G.R., Drebs, A., van Engelen, A.F.V., Førland, E.J., Hanssen-Bauer, I., Heino, R., Jónsson, T., Jonasson, K., Keegan, L., Nordli, P.Ø., Schmidt, T., Steffensen, P., Tuomenvirta, H., Tveito, O.E., 1996: North Atlantic Climatological Dataset (NACD Version 1) - Final Report, Danish Meteorological Institute, Scientific Report, 96-1

Føyn, N.J. 1915. Das Klima von Bergen. The Museum of Bergen, yearbook 1915-16, No. 2. Bergen. Norway.

Gislefoss, Kristen. 1984. (There does not exist any official report. By personal communication a printed text in Norwegian language is given. There is no title).

Hanssen-Bauer, I., P.Ø. Nordli, E.J. Førland. 1996. Principal component analysis of the NACD temperature series. DNMI-klima, Report No. 1/96, 24 pp.

Heino, R. 1973. Lämpötilan vuorokausivaihtelusta ja siihen vaikuttavista tekijöistä. Tutkimusseloste 46, FMI, 58 p.

Heino, R. 1994. Climate in Finland during the period of meteorological observations. Finnish Meteorological Institute. Contributions 12, 209 pp.

Hovmöller, E. 1960. Climatological information on Iceland, UN report No: TAO/ICE/4, New York 23 June 1960.

Høgåsen, S. 1996. Stasjonshistorie for norske verstasjoner. DNMI-klima, In press.

IPCC. 1992. Climate change 1992: The supplementary Report to the Intergovernmental Panel on Climate Change Scientific Assessment. Cambridge University Press, Cambridge, UK, 200 pp.

IPCC. 1995. Climate change 1995: The IPCC Second Scientific Assessment of Climate Change. (In press).

Johannesson T, Jonsson T, Kallen E, Kaas E (1995). Climate change scenarios for the Nordic countries. *Climate Research* 5;3: p181-195.

Johansson, O.V. 1906. Über die Bestimmung der Lufttemperatur am Meteorologischen Observatorium in Helsingfors. *Wissenschaftliche Beilage, Meteorologische Jahrbuch für Finland*. Bd. I 1901, 110 p.

Kreil, K. 1848. Entwurf eines Meteorologischen Beobachtungssystem für die Österreichische Monarchie. III Hefte der Sitzungsberichte der Kaiserlichen Akademie der Wissenschaften.

Langlo, K. 1947. Investigation of air temperature observed in various types of Norwegian thermometer screens. *Meteorologische analer*. Vol. 2, No.12. 387-402.

Nautisk-Meteorologiska Byrån, 1879. Instruktion för meteorologiska observationers utförande vid Svenska Fyrstationer. Kongl. Boktryckeriet, Stockholm.

Mawley, E. 1897. Shade temperature. *Quarterly Journal of the Royal Met. Soc.* Vol. 23, No 102, p. 69-87.

Modén, H. 1939. Beräkning av medeltemperaturen vid svenska stasjoner. *Statens Meteorologisk-Hydrografiska Anstalt. Communications. Series of Papers*, No. 29, 1939, 12pp.

Modén, H. 1954. Termometeruppställningar - en kort jämförelse mellan fristående bur och huv. *Notiser och preliminära rapporter*, Vol 1, No. 3, SMHI 1954, 12 pp.

Modén, H. 1963. Jämförelse mellan olika instrumentuppställningar vid gamla observatoriet i Stockholm. *Notiser och preliminära rapporter, serie Meteorologi*, No. 3, SMHI, 8 pp.

Mohn, H., 1872: Om Vind og Vejr. *Meteorologiens Hovedresultater*, Christiania 1872.

Nielsen, C. 1860. Vejledning ved meteorologiske Iagttagelser. Trykt som Manuscript til Brug ved Statens Telegrafstationer. Christiania 1860, 13 pp. (Instructions for meteorological observations). Manuscript in Norwegian in the library of the Norwegian Meteorological Institute.

Nordli, P.Ø. 1995a. Kontroll og retting av Blåbokdata i perioden 1864 - 1900. *DNMI-klima, report No. 04/95*. (Appendix 3 in English, 3 pp.).

Nordli, P.Ø. 1995b. Adjustments of Temperature Time Series in winter Topo Climate. Results from Dombås Test Field, *DNMI-klima, report No. 05/95*, 20 pp.

Parker, D.E. 1992. Effects of changing exposure of thermometers at land stations. *International Journal of Climatology*, Vol. 14, 1-31, 1994.

Sparks, W.R. 1972. The effect of thermometer screen design on the observed temperature. WMO - No. 315, pp 106. Geneva, Switzerland.

Utaaker, K. 1956. Studies in Local and Micro-meteorology at Kleppe. Investigations on the Air Temperature Observed in various Types of Thermometer Screens. University of Bergen. Yearbook 1956.

VI. 1962. Annual report of the Icelandic Met. Office, 1962.

Wild, H. 1879. Aufstellungen der Thermometer zur Bestimmung der wahren Lufttemperatur. *Reportorium für Meteorologie*. Bd. VI No. 9, St. Petersburg.

WMO. 1983. Guide to Meteorological Instruments and Methods of Observations. Fifth edition, WMO - No. 8, World meteorological Organisation, Geneva.

WMO. 1990. Commission for instruments and methods of observation. Abridged final report of the tenth session. Brussels 11-22 September 1989. No. 727, 125 pp.

WMO. 1995. WMO statement on the status of the global climate in 1994. WMO-report - No. 826, Geneva, 20 pp.

APPENDIX I

Comparison measurements at two Icelandic stations.

Síðumúli: July 8, 1958 - July 7, 1959.

Eyrarbakki: August 11, 1961 - end of December 1962

Observation hours in UTC

Table 1. Temperature difference (°C) free-standing screen - wall screen at Síðumúli, Western Iceland.

Obs. hours	April - August					September - March				
	9	12	15	18	21	9	12	15	18	21
Av. diff.	-0.3	-0.3	-0.3	-0.5	-0.4	0.1	0.0	0.0	0.1	0.2
St. dev.	0.3	0.3	0.4	0.7	0.5	0.4	0.3	0.3	0.3	0.3

Table 2. Temperature difference (°C), April - August at 18 UTC, free-standing screen - wall screen at Síðumúli, Western Iceland at different classes of cloud cover (oktas).

	Cloud cover				Precipitation or not		Low cloud cover	
	0-3	4-6	7	8	«dry»	«wet»	0-7	8
Av. diff	-1.0	-0.8	-0.5	-0.3	-0.4	-0.1	-0.5	-0.1
St. dev.	0.7	0.8	0.5	0.5	0.6	0.3	0.8	0.3
No. of obs.	25	27	37	64	36	28	25	39

Table 3. Temperature difference (°C) free-standing screen - wall screen at Eyrarbakki, Southern Iceland.

Obs. hours	April - August						September - March					
	9	12	15	18	21	24	9	12	15	18	21	24
Av. diff.	0.0	0.4	0.2	0.1	-0.1	-0.2	-0.1	0.0	0.0	0.1	-0.1	-0.1
No. of days	0.5	0.6	0.5	0.4	0.3	0.2	0.3	0.3	0.3	0.3	0.3	0.3

Table 4. Temperature difference (°C), April - August at 12 UTC, free-standing screen - wall screen at Eyrarbakki, Southern Iceland at different classes of cloud cover (oktas).

	Cloud cover				Precipitation or not		Low cloud cover	
	0-3	4-6	7	8	«dry»	«wet»	0-7	8
Av. diff	1.0	0.6	0.4	0.0	0.1	0.0	0.1	-0.1
St. dev.	0.6	0.6	0.5	0.4	0.4	0.4	0.4	0.3
No. of obs.	25	18	68	63	22	41	34	29

APPENDIX II

Calculation of mean monthly temperature

If T is the temperature observed continuously as a function of time t , the strict definition of mean temperature T_m is

$$(1) T_m = \frac{1}{t_2 - t_1} \int_{t_1}^{t_2} T dt$$

If T has been observed with sufficiently small time intervals, all intervals being equal, T_m may be found as the arithmetical average of all the observed temperatures

$$(2) T_m = \frac{1}{N} \sum_{i=1}^{i=N} T_i$$

Some climatologists have defined T_m according to (2) with fixed time intervals, usually 1 hour.

At some main weather stations observations are carried out at three hour intervals, i.e. 8 observations a day at UTC 00, 03, 06...21. Evaluation of formula (2) on data from such stations has shown that the formula is sufficiently accurate for calculation of mean monthly temperature. Then, with the notations in the frame:

T_m	Monthly mean temperature.
T_c	Monthly mean temp. at clock hour c.
T_x	Monthly mean of daily max. temp.
T_n	Monthly mean of daily min. temp.

$$(3) T_m = \frac{T_{00} + T_{03} + \dots + T_{21}}{8}, \text{ time} = \text{UTC}$$

At most manual stations observations are not carried out at equal time intervals. To get unbiased values of T_m it has shown necessary to use weighted averages of the observations at fixed clock hours and often also monthly averages of the daily extreme temperatures are included:

$$(4) T_m = a_1 T_{c1} + a_2 T_{c2} + \dots + a_N T_{cN} + a_x T_x + a_n T_n + k$$

where $T_{c1}, T_{c2}, \dots, T_{cN}$ are mean values of the fixed hour observations and $a_1, a_2, \dots, a_N, a_x, a_n$, and k are constants appropriate for the month and the place.

Below follows a survey of formulas used to calculate T_m in the Nordic countries. The list does not pretend to be complete, especially for formulas no longer in use. It will be seen that the formulas, except the one used for Denmark, are simplifications of formula (4).

Denmark.

The monthly mean temperature is obtained for Danish stations (except Faroe Island and Greenland) from the following formula (DMI, 1983):

$$(5) T_m = M - C, \text{ where}$$

$$(6) M = \frac{T_{08} + T_{14} + T_{21}}{3}$$

C is a tabulated quantity dependent of the amplitude function S defined by:

$$(7) S = T_{14} - \frac{T_{08} + T_{21}}{2}$$

If a station has other hours of observation (which as far as possible are avoided), for instance at hours a, b and c, then

$$(8) C = \frac{S(V_a + V_b + V_c)}{3(V_b - (\frac{V_a + V_c}{2}))}$$

where S is given by formula (7) with a, b and c replacing 08, 14 and 21. The quantities V_a , V_b , and V_c are tabulated (DMI, 1984).

On Faroe Islands is used:

$$(9) T_m = \frac{T_{08} + T_{14} + 2 \cdot T_{21}}{4}$$

In Greenland a variety of formulas have been used during the period of instrumental observations. From Frich (1993) the following formulas are quoted:

1873 - 1883:

$$(10) T_m = \frac{2T_{08} + 2T_{14} + 5 \cdot T_{21}}{9}$$

1884 - 1960:

$$(11) T_m = \frac{2T_{08} + 2T_{14} + 5 \cdot T_{21}}{9} - k$$

The time used was local West Greenland time (UTC - 3^{1/2}) up to 1926, and from 1927 the time was changed to West Greenland time (UTC - 3).

1961 - 1980:

$$(12) T_m = \frac{4T_{00} + T_{12} + T_{18}}{6}, \text{ time = UTC}$$

Since 1958 also formula (3) is used.

Finland

A survey of Finnish formulas has been published by Heino (1994) comprising results from his research. From that publication the following formulas are quoted.

Until 1880:

$$(13) T_m = \frac{T_{07} + T_{14} + T_{21}}{3} + k_1$$

Until 1880 (lighthouses)

$$(14) T_m = \frac{T_{09} + T_{21}}{2} + k_2$$

1881 - 1900

$$(15) T_m = \frac{T_{07} + T_{14} + T_{21}}{3}$$

1901-1926:

$$(16) T_m = \frac{T_{07} + T_{14} + 2T_{21}}{4}$$

1927-1946

$$(17) T_m = \frac{T_{07} + T_{15} + 2T_{21}}{4} + k_3$$

Since 1947:

$$(18a) T_m = \frac{2T_{08} + T_{14} + 2T_{20}}{5} + k_4$$

and (18b)

$$T_m = \frac{T_{08} + T_{14} + 2T_{20}}{4} + k_5(T_{20} - T_n) + k_6$$

where (18a) is used from October to February and (18b) is used from March to September.

If night observations are available:

Since 1959:

$$(19) T_m = \frac{T_{02} + T_{08} + T_{14} + T_{20}}{4} + k_7,$$

or formula (3) if all 8 observations are available.

Mean monthly temperatures calculated by formulas (15) and (16) gave too high temperature, in summer up to 0.9 °C and averages for the whole year up to 0.3°C (Heino, 1973, 1994). Mean temperature calculated by these formulas have been printed in yearbooks up to 1926, but later recalculations are performed. Corrected values are present in data files of FMI.

Iceland

In 1955 a change in the average temperature formulas was implemented in Iceland. The formulas in use before that varied from station to station, but usually incorporated averages of at least 3 observing hour means. Before the Icelandic Met. Office took over the observations in 1920 Danish formulas were in use, namely both (10) and (11), local Icelandic time (UTC-1). It is, however almost certain that the time used was the local mean solar time, which varies from about UTC-1 in East-Iceland to UTC-1.5 in the west. In addition to this a variation of (9) was used at some stations where one made the morning observation at 7 instead of 8,

$$(20) T_m = \frac{T_{07} + T_{14} + 2T_{21}}{4}$$

and from 1913 another variation replacing (20) (no stations observing at 7 but some at 20 instead of 21) namely

$$(21) T_m = \frac{T_{08} + T_{14} + 5T_{20}}{7}$$

during summer adding a correction as in (11)

After 1920 the procedures varied from station to station. A few were equipped with thermographs. Before 1955 one read these with two hour intervals and calibrated by comparison with usual climatological measurements in the same cage. This practice has continued at a few stations to the present time with the only change being that the reading interval has been changed to 3 hours. During the period 1920 - 1955 a lot of formulas (at least 10) were in use, the reason mainly being the irregular observation hours at the different synoptic stations. Most of the formulas included at least three observing hour means.

As soon as the comparison measurements began it became apparent that the observations at UTC 15 was usually the most sensitive to changes of screens. The use of the UTC 15 observations was then discontinued and one reverted to formulas based on two clock hour means, at most stations the observations at 9 and 21 respectively, but at a few synoptic stations not making any observations at 21 UTC, the 9 and 18 UTC observations were used for monthly average calculations. In 1961 the evening observation at the climatic stations was moved from 22 UTC to 21 UTC.

At stations with 8 measurements pr. 24 hours formula (3) above has been used with the variation that 24 UTC replaces 00 UTC, i.e. 3 UTC is the first observation on a new day. As a number of stations actually observe 8 times pr. 24 hours and in addition there are a few thermograph stations in operation it was possible to use this information for the calculation of the correction factors in the below formulas. The correction factors vary seasonally and depend also on the location, but these

variations were in most cases well behaved.

The formulas in use since 1955 are thus in addition to (3):

Time UTC

$$(22a) T_m = \frac{T_{09} + T_{21}}{2} + k_1$$

Time UTC, at climatic stations before 1961.

$$(22b) T_m = \frac{T_{09} + T_{22}}{2} + k_2$$

Time UTC

$$(23) T_m = \frac{5T_{09} + T_{18}}{6} + k_3$$

Before 1968 all publications refer to the Icelandic mean time, $IMT = UTC - 1$, but since then UTC has been in use. This change did not affect the observations relative to the mean solar time.

During the period prior to 1955 there are systematic discrepancies in the published values and "correct" values due to **both** formula inhomogeneities **and** screen effects, especially during summer.

A thorough overview of the formula change in Iceland in 1955 is found in Hovmöller, E. (1960).

Norway

At Norwegian weather stations the minimum thermometer was not in common use before 1876. The mean monthly temperature, T_m , had therefore to be calculated only on the basis of mean temperatures at three fixed hours, 8^h, 14^h, and 20^h local time. In the year books, where the mean monthly temperature was published, the T_{14} was omitted and T_m calculated according to the following simple formula, (Birkeland, 1935)

$$(24) T_m = \frac{T_{08} + T_{20}}{2} + k_1 = T_q + k_1$$

The advantage of formula (24) is that the correction term k_1 turned out to be rather small, in most cases less than 0.5°C.

Analysis of temperature data in the official archive at DNMI (Nordli, 1995a) has shown that T_m before 1876 has been recalculated by the formula:

$$(25) T_m = T_q + k_2(T_{14} - T_q)$$

where T_q is the mean value of T_{08} and T_{20} , k_2 is a constant dependant of place and month.

From 1876 the minimum temperature was incorporated into the formula for the mean temperature. Different formulas were used in the period 1876 to 1889, but from 1890 a formula attributed to Köppen has been used at DNMI. Later T_m was recalculated by that formula also for the period 1876 - 1889.

$$(26) T_m = T_f - k(T_f - T_n)$$

where T_f is the mean of the three observations at fixed hours and k is a constant. The magnitude of k depends on the location, the time of the year and the observation hours. The k -values were calculated from hourly observations in Oslo, Bergen, Trondheim, Alta and Vardø. For the other stations k was established from map interpolations.

Since 1876 observations have been taken at following hours. (Some stations may have somewhat different obs. hours):

01.1876 - 06.1910: 8, 14, 20 local time
07.1910 - 06.1920: 8, 14, 20 CET
07.1920 - 12.1938: 8, 14, 19 CET
01.1949 - 06.1949: 8, 13, 19 CET
Since 07.1949: 7, 13, 19 CET.

Thus k had to be changed in 1920, 1938, and two times in 1949. Minor changes also took place in 1894 when a new procedure for observing minimum temperature was introduced. With the present observation hours 07^h, 13^h and 19^h $k \leq 0.25$ and in Northern Norway $k \leq 0.2$. Maximum occurs in midsummer, minimum in midwinter. In Finnmark and in the Arctic $k \approx 0$ for three to five months of the year.

From 1996 formula (3) will be used if the required 8 observations at fixed hours are available.

Sweden

Mainly two formulas have been used, but with some modifications due to changes in observing hours. The two formulas are (In Swedish time = CET = UTC + 1).

Edlunds formula:

$$(27) T_m = \frac{T_{08} + T_{14} + 5T_{21}}{7}$$

From 1 January 1879 a common time was introduced in Sweden. Before that observations were made at local times 8, 14 and 21, although probably with fairly large deviations due to not very precise clocks and no great need for exact times. At lighthouse stations readings were made at 9, 14 and 21 hours but from 1871 the morning reading was changed to 8^h.

From 1 January 1914 the Ekholm formula (later called Ekholm-Modén formula) was adopted (with coefficients varying with longitude and determined from a few stations with hourly data).

Ekholm-Modén formula:

$$(28) T_m = aT_{08} + bT_{14} + cT_{21} + dT_n + eT_x$$

In the first version coefficient e was zero. All monthly temperatures for 1901-1913

were recalculated with the new formula and it is these recalculated values that are stored on files with monthly values in the data archive at SMHI.

From 1 January 1941 to 31 December 1946 the evening reading was made at 19^h. Thus a new set of coefficients was used during this period.

From 1 January 1947 the present observing times (07, 13, 19 = 06, 12, 18 UTC) have been used. Thus a second recalculation of coefficients was performed.

From 1 January 1986 a new set of coefficients was adopted. In fact this set had been developed earlier (1965) for deriving daily means but for some 20 years slightly different formulas were used for daily and monthly mean calculations. These present values of the coefficients were published in 1965 (In Meteorological Observations in Sweden).

From 1994, some stations are operating with a reduced programme where the observation at 13^h is not performed. At those stations the T_{13} value is estimated from the observations T_{07} , T_{19} and T_x using an expression analogous to Ekholm-Modén's formula but where the coefficients vary with latitude instead of longitude. Then Ekholm-Modén's formula (28) is used as earlier.

Comparisons between Edlunds and Ekholm-Modén's formulas have been made. Results may differ much from one station to another but it is quite common that Edlunds formula gave 0.2-0.3°C lower values in early and mid winter but up to 0.3-0.4°C higher values in June and July. For maritime stations differences are, naturally, smaller and as a rule negligible. There are some indications that the most recent Ekholm-Modén coefficients give somewhat lower mean values than the earlier versions but mainly the differences seem to be within 0.1°C.